



Thermo Plastic Pressure Pipe Systems

Price List 2017
Tarif 2017
Preisliste 2017
Listino Prezzi 2017
Lista de Precios 2017

Effast from Polypipe Italia is a well-established brand name that is recognised throughout both the industrial process market and construction industries for its market-leading range of thermoplastic pipework systems suitable for use within industrial applications. The company now provides these components to customers all over the world and leads the way in the research and development of advanced new solutions that satisfy the specific needs of the market.

Polypipe, with its large UK based manufacturing capabilities, has developed Effast's comprehensive product portfolio such that it now offers a proven and effective solution to virtually any requirement. No matter the project, the Effast range can offer the perfect combination of pressure pipe fittings, ball, butterfly, diaphragm and actuated valves, compression joints, adaptors and other fittings. Normally available in different standards, these products are suited to many different commercial applications in such areas as food and beverage processing, chemical manufacture, water treatment and agriculture.

Outstanding performance and reliability have come to represent the hallmarks by which Polypipe's Effast products are recognised and with these products also carrying BSI Kitemark accreditation and conforming to various other Quality european standards (KIWA, NF, KIWA UNI, DVGW, WRAS, GOST) they can be specified with complete confidence. Polypipe Italia is certified ISO 9001 and ISO 14001: 2015.

Dedicated to supporting its customers at every stage, the company also complements its products and systems with a full technical information and support service, while a nationwide distribution network means that products are readily available, even when needed next day.

For further information please see our contact details on the back cover of this brochure.

Il marchio EFFAST è presente da molti anni sul mercato ed è molto apprezzato e riconosciuto sia per le applicazioni di tipo industriale sia per le applicazioni proprie del campo delle costruzioni civili e dell'agricoltura.

I raccordi e le valvole a marchio EFFAST sono prodotti in Italia e sono venduti nel mondo avendo come riferimento la soddisfazione dei Clienti, se necessario anche attraverso la ricerca e lo sviluppo di soluzioni personalizzate.

Il Gruppo Polypipe, produttore della più ampia gamma di sistemi di tubazione in plastica, ha costantemente investito nella propria consociata Polypipe Italia così da farla diventare un'azienda di qualità, capace di offrire una soluzione valida per ogni tipo di esigenza. In effetti, qualunque progetto o applicazione riferita a impianti in pressione trova nella gamma EFFAST una perfetta combinazione di raccordi, valvole a sfera, valvole a farfalla, valvole a membrana, valvole motorizzate, giunti rapidi, adattatori ed altro ancora. Tutti i prodotti a marchio EFFAST sono disponibili in diversi standard e sono adatti per essere utilizzati nei processi dell'industria alimentare così come in quelli dell'industria chimica, del trattamento acque e dell'irrigazione.

Il prodotti EFFAST sono certificati con i principali marchi di qualità (BSI, KIWA, NF, KIWA UNI, DVGW, WRAS) e la Polypipe Italia è un'azienda certificata ISO 9001 (certificazione di sistema) ed ISO 14001: 2015 (certificazione ambientale); la Qualità caratterizza quindi i prodotti di un'azienda che vuole offrire ai propri Clienti la massima affidabilità e la migliore conformità alle specifiche di progetto.

La missione della Polypipe Italia si completa offrendo un costante sostegno ai propri Clienti nell'offrire loro tutte le necessarie informazioni di natura tecnica e garantendo altresì un ottimo servizio di consegna.

Il dettaglio dei nostri contatti è nell'ultima pagina di questo Listino.





POLYPIPE ITALIA

Situated 40 kms away from Genova with a 2500 m² covered warehouse, a production unit of 24 machines for a total of 50 people, Polypipe Italia has now become an important producer of fittings and valves for high pressure pipe systems in PVC , ABS, and PPH polyfusion materials. Our products are distributed all over the Italian market through a wide network of highly qualified representatives and exported all around the world through specialist distributors.

MARKETS

Our products are sold through wholesalers & distributors in the water treatment, swimming pool & spa business, building & construction sector, agriculture & irrigation installations, industrial applications in all type of pressure piping systems.

Effast fittings and valves are easy to install, corrosion resistant, cover a wide range of temperature and have an excellent chemical resistance.

SERVICE

Our medium delivery time for export is 3 weeks thanks to a constant control over a good level of stock and a dedicated staff who always guarantee you good service for good value.

Our commercial team will assist you in a very professional way on both technical and logistics matters, and on price quotations.

POLYPIPE ITALIA

Situata a 40 km da Genova, con un magazzino di 2500 m² coperti, un'unità di produzione di 24 macchine ed un totale di 50 persone, Polypipe Italia è ormai diventata un importante produttore di raccordi e valvole per sistemi di tubazioni a pressione in PVC, ABS, e PPH.

I nostri prodotti sono distribuiti in tutto il mercato italiano ed esportati in tutto il mondo attraverso agenti e distributori specializzati.

MERCATI

I nostri prodotti vengono impiegati nei settori trattamento acque, piscina e wellness spa, agricoltura e impianti di irrigazione, nelle applicazioni industriali e in tutti i sistemi di tubazioni a pressione. I raccordi e le valvole EFFAST sono facili da installare, resistenti alla corrosione, a diverse temperature e sollecitazioni chimiche.

SERVIZIO

I tempi di consegna per l'Italia sono di 7 giorni e per l'esportazione sono di 3 settimane, grazie alla gestione costante del livello di stock.

Il nostro team commerciale è a vostra disposizione per soddisfare ogni richiesta tecnica, logistica e per lo studio di quotazioni personalizzate.

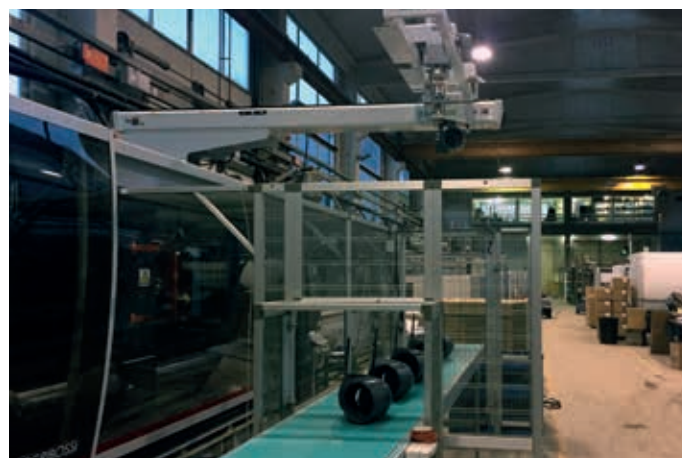

QUALITY

Our internal laboratory tests directly the complete range of production according to the regulations of all main European norms (NF, KIWA, UNI, KITE MARK, DVWG). Effast ball and industrial valves are tested one by one against leakage, and the complete range of our products is been tested by our internal laboratory department. All Effast fittings and valves are produced with certified compound raw material which guarantees full security on mechanical and pressure resistance and is fit for contact with alimentary fluids and potable water. The O'rings used in valves are certified materials: EPDM, FKM, NBR. Polypipe Italia is an ISO 14001 certified company.

QUALITÀ

Il nostro laboratorio interno effettua giornalmente test sull'intera gamma prodotta secondo i regolamenti di tutte le principali norme europee (NF, KIWA UNI, KITE MARK, DVGW) e tutte le valvole industriali sono testate singolarmente contro le perdite. I raccordi e le valvole EFFAST sono prodotti con materie prime certificate che garantiscono la sicurezza sulla meccanica e resistenza alla pressione e sono idonei al contatto con liquidi alimentari e acqua potabile. Gli o-rings utilizzati sono in materiali certificati: EPDM, FKM, NBR. Polypipe Italia è una società certificata ISO 14001.



Quality Marks	6
Effast Product Code Guide	7
Working Conditions	8 / 9
Key	10

PVC-u 11

Solvent Cement Fittings	12 / 17
Unions	18 / 19
Adaptor Fittings	20 / 23
BSP Parallel Threaded Fittings	24 / 26
Solvent Cement Fittings BS	27 / 29
Adaptor Fittings BS	30 / 32
Accessories	32 / 33
Pipes	34
Flowmeters	35
Industrial Ball Valves - BK Range	37
Industrial Ball Valves - BX / SX Range	38
3 Ways Ball Valves	39
Water Ball Valves - BV Range	40
Water Ball Valves ASTM / NPT / JIS	40
Water Ball Valves - SV Range	41
Check Valves	42 / 43
Ball Check Valve	43
Air Release Valves	43 / 44
Foot Valves	44
Inclined Seat Valves	45
Sightglass	45
Swing Check Valve	46
Metric Gate Valve	46
Butterfly Valves	48 / 49
Electrically Actuated Ball Valves	51
Pneumatically Actuated Ball Valves	51
Electrically Actuated Butterfly Valves	52
Pneumatically Actuated Butterfly Valves	52 / 53
Diaphragm Valves	53

GLUE 54

Solvent Cement, Cleaner, PTFE Tape	55
------------------------------------	----

ABS FITTINGS & VALVES 56

Solvent Cement Fittings BS	57 / 59
Adaptor Fittings BS	60 / 61
Pipes	62
Industrial Ball Valves BS	63
Check Valves BS	63
Air Release Valve BS	63
Electrically Actuated Double Union Ball valve BS	64
Pneumatically Actuated Double Union Ball Valve BS	64

ABS RED PIPES & FITTINGS 65 / 66

PPH FITTINGS AND VALVES 67

Fittings for Socket Fusion Jointing	68 / 69
Industrial Ball Valves	70
Check Valves	70
High performance PPH Butterfly Valves	71
Pipes	71

PE 100 FITTINGS 72

E-Fusion Fittings	73
Clamp Saddles	74
Butt Welding Fittings with Elongated Spigots	75

COMPRESSION FITTINGS AND CLAMP SADDLES 76

Compression Fittings	77 / 79
Clamp Saddles	80 / 81

SPARE PARTS for valves and fittings 82 / 85

GENERAL SALES TERMS 86



Marques de Qualité	6
Guide Code Produits Effast	7
Conditions d'Utilisation	8 / 9
Légende	10

PVC-u 11

Raccords à Coller	12 / 17
Union 3 pièces	18 / 19
Raccords d'adaptation	20 / 23
Raccords Filetés	24 / 26
Raccords à Coller BS	27 / 29
Raccords d'adaptation BS	30 / 32
Accessoires	32 / 33
Tuyaux	34
Débitmètres	35
Vannes à Boisseau Sphérique pour Industrie - Série BK	37
Vannes à Boisseau Sphérique pour Industrie - Série BX / SX	38
Vannes 3 Voies	39
Vannes à Boisseau Sphérique - Série BV	40
Vannes à Boisseau Sphérique ASTM / NPT / JIS	40
Vannes à Boisseau Sphérique - Série SV	41
Soupapes	42 / 43
Soupape à Bille	43
Ventouse	43 / 44
Vannes à Pié	44
Vannes à Soupape à tête inclinée	45
Indicateur de Flux	45
Clapet à Battant	46
Vannes à Guillotine	46
Vannes à Papillon	48 / 49
Vannes Motorisées à Commande Électrique	51
Vannes Motorisées à Commande Pneumatique	51
Vannes à Papillon à Commande Électrique	52
Vannes à Papillon à Commande Pneumatique	52 / 53
Vanne à Membrane	53

COLLE 54

Colle, Diluent, Ruban en PTFE	55
-------------------------------	----

RACCORDS EN ABS 56

Raccords à Coller BS	57 / 59
Raccords d'adaptation BS	60 / 61
Tuyaux	62
Vannes à Boisseau Sphérique pour Industrie BS	63
Soupapes BS	63
Ventouse BS	63
Vannes Boisseau Sphérique à Commande Électrique BS	64
Vannes Boisseau Sphérique à Commande Pneumatique BS	64

TUYAUX ET RACCORDS EN ABS ROUGE 65 / 66

RACCORDS ET VANNES EN PPH 67

Raccords pour Soudure dans l'Emboîture	68 / 69
Vannes à Boisseau Sphérique pour Industrie	70
Soupape	70
Vannes à Papillon à Hautes Performance	71
Tuyaux	71

RACCORDS PE 100 72

Raccords	73
Collier de Prise en Charge	74
Raccords avec Extrémités allongées pour Soudure Boût-a-Boût	75

RACCORDS À PRESSION ET COLLIER DE PRISE 76

Raccords à Pression	77 / 79
Collier de Prise	80 / 81

PIÈCES DETACHÉES pour vannes et raccords 82 / 85

CONDITIONS GÉNÉRELLES DE VENTE 86



Qualitätskennzeichen	6
Effast Artikelnummer	7
Gebrauchsbedingungen	8 / 9
Hinweistext	10

PVC-u 11

Klebefittings	12 / 17
Verschraubungen	18 / 19
Übergangsfittings	20 / 23
Gewindefittings	24 / 26
Klebefittings BS	27 / 29
Übergangsfittings BS	30 / 32
Zubehöre	32 / 33
Rohre	34
Durchflussmesser	35
Kügelhähne Industrie - Serie BK	37
Kügelhähne Industrie - Serie BX / SX	38
3 Wege Kügelhähne	39
Kügelhähne Wasser - Serie BV	40
Kügelhähne Wasser ASTM / NPT / JIS	40
Kügelhähne Wasser Serie SV	41
Rückschlagventile	42 / 43
Kugelrückschlagventil	43
Be-U. Entlüftungs Ventile	43 / 44
Fußventile	44
Schrägsitzventile	45
Wasserlauf Anzeiger	45
Rückschlagklappe	46
Absperrschieber	46
Absperrklappe	48 / 49
Kügelhähne mit Elektroantrieb	51
Kügelhähne mit Pneumatikantrieb	51
Absperrklappe mit Elektroantrieb	52
Absperrklappen mit Pneumatikantrieb	52 / 53
Membranventile	53

KLEBER 54

Kleber, Reinigungsmittel, Band aus PTFE	55
---	----

KLEBEFITTINGS AUS ABS 56

Klebefittings BS	57 / 59
Übergangsfittings BS	60 / 61
Rohre	62
Kügelhähne BS	63
Kugelrückschlagventile BS	63
Be-und-Entlüftungsventile BS	63
Kügelhähne mit Elektroantrieb BS	64
Kügelhähne mit Pneumatikantrieb BS	64

ROTE ROHRE UND KLEBEFITTINGS AUS ABS 65 / 66

FITTINGS UND KUGELHÄHNE AUS PPH 67

Muffenschweißfittings	68 / 69
Industrie Kügelhähne	70
Rückschlagventile	70
Hochleistungsabsperrklappen	71
Rohre	71

FITTINGS AUS PE 100 72

Fittings	73
Anbohrschellen	74
Fittings mit langen Schweissenden	75

KLEMMVERBINDER UND ANBOHRSCHELLEN 76

Klemmverbinder	77 / 79
Anbohrschellen	80 / 81

ERSATZTEILE für Kügelhähne und Fittings 82 / 85

ALLGEMEINE VERKAUFSBEDINGUNGEN 86



Marchi di qualità	6
Guida al Codice Prodotto	7
Condizioni di Utilizzo	8 / 9
Legenda	10

PVC-u	11
Serie Metrica per Incollaggio	12 / 17
Bocchettoni	18 / 19
Raccordi di Passaggio	20 / 23
Serie Filettata	24 / 26
Raccordi Incollaggio BS	27 / 29
Serie di Passaggio BS	30 / 32
Accessori	32 / 33
Tubi	34
Flussimetri	35
Valvole a Sfera per Industria - Serie BK	37
Valvole a Sfera per Industria - Serie BX / SX	38
Valvole a 3 Vie	39
Valvole a Sfera per Industria - Serie BV	40
Valvole a Sfera ASTM / NPT / JIS	40
Valvole a Sfera per Industria - Serie SV	41
Valvole di non ritorno	42 / 43
Valvola di non Ritorno a Palla	43
Valvole sfogo aria	43 / 44
Valvole di fondo	44
Valvole a sede inclinata	45
Indicatore di Flusso	45
Valvola a Clapet	46
Valvole a Ghigliottina	46
Valvole a Farfalla	48 / 49
Valvole Attuate a Comando Elettrico	51
Valvole Attuate a Comando Pneumatico	51
Valvola a Farfalla a Comando Elettrico	52
Valvola a Farfalla a Comando Pneumatico	52 / 53
Valvole a Membrana	53

COLLA	54
Colla, Diluente, Nastro in Ptfе	55

RACCORDI IN ABS	56
Raccordi Incollaggio BS	57 / 59
Raccordi di Passaggio BS	60 / 61
Tubi	62
Valvole a Sfera Radiali Industria BS	63
Valvole di Ritegno BS	63
Valvole Sfogo Aria BS	63
Valvola Sfera Radiale Attuatore Elettrico BS	64
Valvola Sfera Radiale Attuatore Pneumatico BS	64

RACCORDI E TUBI IN ABS ROSSO	65 / 66
-------------------------------------	----------------

RACCORDI E VALVOLE IN PPH	67
Raccordi per Saldatura nel Bicchiere	68 / 69
Valvola a Sfera per Industria	70
Valvola di non ritorno	70
Valvole a Farfalla Alte Prestazioni	71
Tubi	71

RACCORDI IN PE 100	72
Raccordi Elettrosaldabili	73
Collari di Presa in Carico	74
Raccordi Testa a Testa con Estremità Allungate	75

GIUNTI A COMPRESSIONE E PRESE A STAFFA	76
Giunti a Compressione	77 / 79
Prese a Staffa	80 / 81

PARTI DI RICAMBIO per valvole e raccordi	82 / 85
---	----------------

CONDIZIONI GENERALI DI VENDITA	86
---------------------------------------	-----------



Marca de Calidad	6
Guía de los artículos Effast	7
Condiciones de Uso	8 / 9
Leyenda	10

PVC-u	11
Serie Lisa para Encolar	12 / 17
Unión	18 / 19
Accesorios Mixto Encolar	20 / 23
Serie Roscada	24 / 26
Accesorios Para Encolar BS	27 / 29
Accesorios Mixto Encolar BS	30 / 32
Accesorios	32 / 33
Tubos	34
Caudalímetro	35
Válvula de Bola para Industria - Serie BK	37
Válvula de Bola para Industria - Serie BX / SX	38
Válvulas de 3 Vías	39
Válvulas de Bola - Serie BV	40
Válvulas de Bola ASTM / NPT / JIS	40
Válvulas de Bola - Serie SV	41
Válvulas Antiretorno	42 / 43
Válvula Antiretorno De Purga	43
Válvulas de purga	43 / 44
Válvulas de Pie	44
Válvulas Asiento Inclinado	45
Medidor de Flujo	45
Válvulas de clapeta	46
Válvulas de guillotina	46
Válvulas de Mariposa	48 / 49
Válvulas de Bola con Actuador Eléctrico	51
Válvulas de Bola con Actuador Neumático	51
Válvulas de Mariposa con Actuador Eléctrico	52
Válvulas de Mariposa con Actuador Neumático	52 / 53
Válvula a Diafragma	53

COLA	54
Cola, Disolvente y Banda en Ptfе	55

ACCESORIOS EN ABS	56
Accesorios para Encolar BS	57 / 59
Serie de Mixta BS	60 / 61
Tubos	62
Válvula de Bola Radial para Encolar BS	63
Válvula Antiretorno BS	63
Válvulas Rejilla BS	63
Válvula de Bola con Actuador Eléctrico BS	64
Válvula de Bola con Actuador Neumático BS	64

TUBOS Y ACCESORIOS ROJOS EN ABS	65 / 66
--	----------------

TUBOS Y ACCESORIOS EN PPH	67
Accesorios para Soldadura en el Vaso	68 / 69
Válvulas de Bola para Industria	70
Válvulas Antiretorno	70
Válvulas a mariposa a alto rendimiento	71
Tubos	71

ACCESORIOS EN PE 100	72
Accesorios Electrosoldables	73
Collarin de Toma en Carga	74
Accesorios con Extremidades Alargadas para Soldadura	75

ACCESORIOS DE COMPRESIÓN Y COLLARINES DE FIJACIÓN	76
Accesorios de Compresión	77 / 79
Collarin de Fijación	80 / 81

PIEZAS DE RESPUESTO para válvulas y accesorios	82 / 85
---	----------------

CONDICIONES GENERALES DE VENTA	86
---------------------------------------	-----------

Quality Marks / Marques de Qualité / Qualitätskennzeichen / Marchi di qualità / Marca de Calidad



UNI EN ISO 9001:2015
UNI EN ISO 14001:2015



UNI EN ISO 1452-3:2010-12
KIP 088883/01



NF 055; NF EN 1452;
NF T 54-029



BS EN 1452-3:2010:2012
KM 60041



BS 5392-1:2006 pt.1
KM 60042



BRL-K 17301
K 21166/03



Certificate no 1705075 (PVC) - Certificate no 1703070 (ABS)
1412307 (valves) - 1511534 (Solvent Cement)



EN 1452-3:2010-12
CW 8621 - CR0141



KTW GUIDELINE
HYG 17122010



ACS (Attestation de Conformité Sanitaire)
14 MATZY 175-176
15 ACCLY 400



BV
Type Approval N° 37396 A BV



1115
Direttiva 2014/68/UE

Effast Product Code Guide / Guide Code Produits Effast / Effast Artikelnummer / Guida al Codice Prodotto / Guía de los artículos Effast

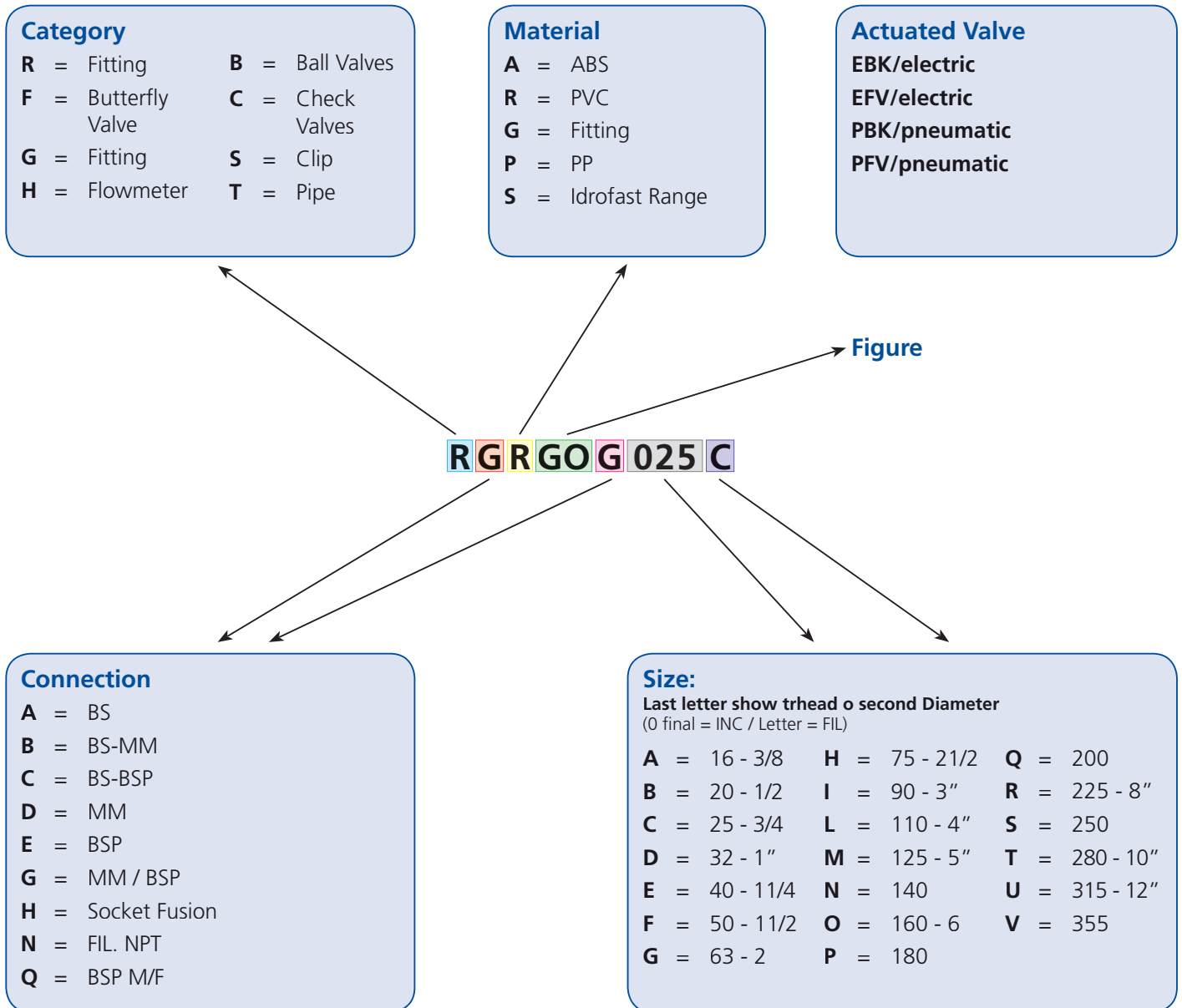

Packing in boxes

EUROPALLET

24 box large - 48 box medium - 96 box small

Bar Code
 EAN 13

RDRGOD0630

PVC
 QTA. 60
 FIG. 0630

PVC GOMITO A 90° 63 MM KG 14.12

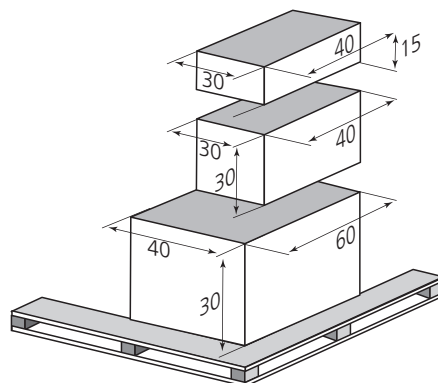

BOX TYPE

S = small	40 x 30 x 15 cm
M = medium	40 x 30 x 30 cm
L = large	60 x 40 x 30 cm
S = small	0.5 kg
M = medium	0.6 kg
L = large	1.0 kg

WORKING CONDITIONS

Fittings and valves of this price list are for PVC, PPH, ABS, PE joints and fluids in pressure, in particular for water supply, until PN/PFA 16 (unless differently specified).

PVC fittings and valves can be used for sewerage too, but never for compressed air systems. For application with aggressive fluids or different temperatures from what indicated, please ask for information.

STANDARDS REFERENCES

Standards of this price list are valid and updated to the date of their publication.

UNI EN 1452: 2010

"Plastics piping systems for water supply. Unplasticized poly (vinyl chloride) (PVC-u). Fitness for purpose of the system"

UNI EN 805:2002

"Water supply. Requirements for systems and components outside buildings"

UNI EN 10226:2006

"Pipe threads where pressure tight joints are made on the threads"

UNI EN ISO 228:2003

"Pipe threads where pressure-tight joints are not made on the threads"

UNI EN 1092:2007

"Flanges and their joints - Circular flanges for pipes, valves, fittings and accessories, PN designated"

ISO 2536 : 1974

"Unplasticized polyvinyl chloride (PVC) pressure pipes and fittings, metric series - Dimensions of flanges"

BRITISH STANDARD BS 10 : 1962

"Specification for Flanges and Bolting for Pipes, Valves, and Fittings"

BS 4505-2:1989

"Circular flanges for pipes, valves and fittings (PN designated). Steel, cast iron and copper alloy flanges"

CONDIZIONI DI UTILIZZO

I raccordi e le valvole inclusi nel presente listino sono destinati alla giunzione di tubi in PVC, PPH, ABS, PE e al convogliamento di fluidi in pressione, in particolare acqua per qualsiasi uso, fino a PN / PFA 16 (se non diversamente indicato).

I raccordi e le valvole in PVC possono essere impiegati anche per linee non in pressione ma non possono essere utilizzati per impianti ad aria compressa. Per utilizzi con fluidi particolarmente aggressivi, o temperature differenti da quelle indicate, richiedere informazioni in azienda.

RIFERIMENTI NORMATIVI

Le norme contenute nel presente listino sono valide e aggiornate al momento della sua pubblicazione..

UNI EN 1452: edizione 2010

"Sistemi di tubazioni di materia plastica per l'adduzione d'acqua - Policloruro di vinile non plastificato (PVC-u)"

UNI EN 805:2002

"Approvvigionamento di acqua - requisiti per sistemi e componenti all'esterno di edifici"

UNI EN 10226:2006

"Filettature di tubazioni per accoppiamento con tenuta sul filetto"

UNI EN ISO 228:2003

"Filettature di tubazioni per accoppiamento non a tenuta sul filetto - dimensioni, tolleranze e designazione"

UNI EN 1092:2007

"Flange e loro giunzioni - flange circolari per tubazioni, valvole, raccordi e accessori designati mediante PN"

Working Conditions / Conditions d'Utilisation Gebrauchsbedingungen / Condizioni di Utilizzo / Condiciones de Uso

PVC-u Operating Temperature and Pressure / Temperatura e Pressioni di Esercizio PVC-u

Operating Temperature Temperatura di esercizio	0° - 25°	25° - 30°	30° - 35°	35° - 40°	40° - 45°
PN / PFA* bar	16	14,4	12,8	11,2	10
PN / PFA* bar	10	9	8	7	6,25
PN / PFA* bar	6	5,4	4,8	4,2	3,6

* According to UNI EN 805 – reduction factor according to UNI EN 1452-2 / * In accordo con UNI EN 805 - fattore di riduzione in accordo con UNI EN 1452-2

Temperature Range / Temperature Limite

PVC	ABS	PPH	PE100
0 °C +60 °C	-40 °C +60 °C	-5 °C +95 °C	0 °C +40 °C

CONNECTION AMONG DIFFERENT TYPES OF PRESSURES

All the components in this price list, according to the standard UNI EN 805, for water supply distribution, have three different working types of pressure: PN / PFA, PMA e PEA.
For each PN/PFA meaning there is a correspondence for PM and PEA, on the basis of the following table:

CORRELAZIONE TRA LE DIFFERENTI PRESSIONI

I componenti, valvole e raccordi, in accordo con la norma UNI EN 805, per la distribuzione di acqua, hanno 3 pressioni di utilizzo: PN / PFA, PMA e PEA.
A ciascun valore di pressione PN / PFA sono associati i valori di pressione PMA e PEA, secondo la seguente tabella:

Operating Temperature and Pressure / Temperatura e Pressioni di Esercizio

	PN / PFA (PN)	PMA	PEA
Pressures in bars / Pressioni in bars	16	20	24
	10	12,5	15
	6	7,5	9

Imperial and Metric Sizes / Sistema Metrico e British Standard

IMPERIAL AND METRIC SIZES

The following notes may be helpful to those unfamiliar with the different ways of describing metric and imperial sizes when specifying pipe or fittings. When specifying Imperial pipe fittings and other components reference is made to the nominal size of the pipe bore in inches and fractions of an inch. Metric Systems are specified by reference to the outside diameter of the pipe expressed in millimetres.

As a general guide, the following table gives a comparison between metric and imperial sizes up to 8 inches. It is important to understand that metric sizes are not simply inch sizes which have been converted into millimetres and called metric. The actual equivalents are slightly different (except for Imperial size 2 1/2 inches and metric size 75mm and 5 inches and 140mm which happen to coincide exactly) and are not interchangeable.

Imperial Sizes (inches)		Metric Sizes (mm)	
Nominal bore	Pipe outside diameter	Pipe outside diameter	Nominal bore
3/8"	17.1	16	10
1/2"	21.4	20	15
3/4"	26.7	25	20
1	33.6	32	25
1 1/4"	42.2	40	32
1 1/2"	48.3	50	40
2	60.3	63	50
2 1/2"	75.2	75	65
3	88.9	90	80
4	114.3	110	100
5	140.2	140	125
6	168.3	160	150
8	219.1	225	200

Max Working in Kg/cm² / Pressione Massima di Utilizzo Kg/cm²

Range / Serie	Dimensions / Dimensioni	PN
Solvent jointing	from D 16 to D 160	16
Solvent jointing	from D 200 to D 315	10
Threaded	from G 3/8" to G 4"	16
Adaptor	from D 16 to D 110	16
Ball Valves	from D 216 to D 63	16
Ball Valves	from D 75 to D 110	10

PN / PFA / PN - Allowable continuous operating pressure

Maximum pressure that a component is capable to maintain in continuous operating (UNI EN 805:2002).

At the temperature of 20°C and operating for 50 years, it remains the same as the marked PN rating.

PMA – Maximum operating pressure

Maximum operating pressure is the pressure occurring from time to time, including surge, that a component is capable of withstanding in service (UNI EN 805:2002).

PEA - Allowable Site Test Pressure

Test pressure that must not be exceeded during commissioning. In general, it should be assumed that all pipe systems will be subjected to a proof hydraulic pressure test at 1.5 times the nominal pressure rating PN of the lowest rated component in the system (UNI EN 805:2002).

PVC-u

Unplasticized Polyvinyl Chloride - High quality compound with a MRS (Minimum Required Strength) of 25N/sq.mm at least.

ABS: Acrylonitrile Butadiene Styrene

PPH: Homopolymer Polypropylene

PE 100: High Density Polyethylene (HDPE) – MRS10

EPDM: Ethylene-Propylene Diene Monomer

FKM: Fluoropolymer elastomer

PTFE: Polytetrafluoroethylene

NBR: Nitrile rubber

BS: British Standard

Rp: Female thread according to UNI EN 10226

R: Male thread according to UNI EN 10226

G: Cylindrical thread UNI EN ISO 228

d: External size of the pipe

DN: Nominal size

D: Inner rubber size

PACKAGING:

Pack: pieces in standard pack

Min. q.ty.: minimum quantity that can be ordered

JIS: Japanese standard

ASTM: American standard

NPT: threaded American standard

PN / PFA / PN - Pressione di esercizio ammissibile

Massima pressione idrostatica che un componente è capace di mantenere in servizio continuo (UNI EN 805:2002).

Alla temperatura di 20° C e per 50 anni di servizio corrisponde alla definizione di PN.

PMA - Massima pressione di esercizio ammissibile

Massimi picchi occasionali di pressione (inclusi i disturbi dovuti a sovrappressioni), che un componente è in grado di resistere in servizio (UNI EN 805:2002).

PEA - Pressione di collaudo ammissibile

Massima pressione idrostatica che un componente nuovo, una volta installato, è capace di mantenere per un periodo di tempo relativamente corto, allo scopo di assicurare l'integrità e la tenuta della condotta (UNI EN 805:2002).

PVC-u

Polivinilcloruro non plastificato - Materia prima di elevata qualità in grado quindi di superare test che ne determinano un MRS (Minimum Required Strength) almeno pari a 25 N/mm²

ABS: Acrilonitrile Butadiene Stirene

PPH: Polipropilene Omopolimero

PE 100: Polietilene Alta Densità (HDPE) – MRS10

EPDM: Copolimero Etilene Propilene

FKM: Gomma fluorurata

PTFE: Politetrafluoroetilene

NBR: Gomma nitrilica

BS: British Standard

Rp: Filettatura interna cilindrica UNI EN 10226 – a tenuta sul filetto

R: Filettatura esterna conica UNI EN 10226 – a tenuta sul filetto

G: Filettatura cilindrica UNI EN ISO 228

d: Diametro esterno del tubo

DN: Diametro Nominale

D: Diametro interno gomma

IMBALLAGGI:

Pack: numero dei pezzi per confezione standard

Q.tà min.: quantità minima per confezione non frazionabile

JIS: standard giapponese

ASTM: standard americano

NPT: standard americano filettato

PVC-u Fittings / Raccordi PVC-u
PVC-u Klebefittings
Raccordi PVC-u / Accesorios PVC-u

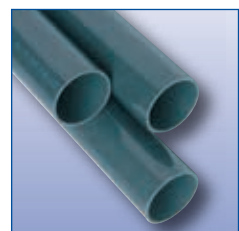

Solvent Cement Fittings (Metric Set) / Raccordi à Coller Klebefittings / Serie Metrica per Incollaggio / Serie Lisa Para Encolar

Elbow 90° / Coude 90° / Winkel 90° / Gomito a 90° / Codo 90°

	Code / Codice	d	PN / PFA	Q.tà min / Min. q.ty	Box	Pack / Imballo	€
GOD	RDRGOD0160	16	16	10	350	S	0,89
	RDRGOD0200	20	16	10	250	S	1,06
	RDRGOD0250	25	16	10	300	M	1,16
	RDRGOD0320	32	16	10	180	M	1,34
	RDRGOD0400	40	16		120	M	2,51
	RDRGOD0500	50	16		120	L	3,35
	RDRGOD0630	63	16		60	L	4,71
	RDRGOD0750	75	16		40	L	11,12
	RDRGOD0900	90	16		25	L	15,13
	RDRGOD1100	110	16		14	L	23,22
	RDRGOD1250	125	16		10	L	44,26
	RDRGOD1400	140	16		6	L	52,81
	RDRGOD1600	160	16		4	L	79,64
	RDRGOD2000	200	10		2	L	163,54
	RDRGOD2250	225	10		1	L	205,91
	RDRGOD2500	250	10		1	L	326,66
	RDRGOD2800	280	10		1	L	510,61
RDRGOD3150	315	10		1	L	578,86	
RDRGOD3550	355	5		1	L	On request	
RDRGOD4000	400	5		1	L	On request	



Elbow 45° / Coude 45° / Winkel 45° / Gomito a 45° / Codo 45°

	Code / Codice	d	PN / PFA	Q.tà min / Min. q.ty	Box	Pack / Imballo	€
GYD	RDRGYD0160	16	16	10	500	S	1,95
	RDRGYD0200	20	16	10	300	S	1,77
	RDRGYD0250	25	16	10	400	M	2,19
	RDRGYD0320	32	16	10	200	M	2,33
	RDRGYD0400	40	16		150	M	3,07
	RDRGYD0500	50	16		150	L	4,18
	RDRGYD0630	63	16		90	L	5,42
	RDRGYD0750	75	16		50	L	10,03
	RDRGYD0900	90	16		30	L	13,66
	RDRGYD1100	110	16		16	L	29,42
	RDRGYD1250	125	16		12	L	38,86
	RDRGYD1400	140	16		6	L	52,89
	RDRGYD1600	160	16		6	L	61,84
	RDRGYD2000	200	10		2	L	141,43
	RDRGYD2250	225	10		2	L	154,78
	RDRGYD2500	250	10		1	L	264,15
	RDRGYD2800	280	10		1	L	401,98
RDRGYD3150	315	10		1	L	535,98	
RDRGYD3550	355	5		1	L	On request	
RDRGYD4000	400	5		1	L	On request	



Reduced elbow 90° plain / Coude réduit 90° / Winkel 90° reduziert / Gomito ridotto a 90° / Codo 90° reducido

	Code / Codice	d	PN / PFA	Q.tà min / Min. q.ty	Box	Pack / Imballo	€
GRD	RDRGRD032C	32x32x25	16	10	180	M	4,17
	RDRGRD040D	40x40x32	16		120	M	6,22
	RDRGRD050D	50x40x32	16		120	L	8,51
	RDRGRD050E	50x50x40	16		120	L	8,51
	RDRGRD063F	63x63x50	16		60	L	12,33
	RDRGRD075G	75x75x63	16		40	L	20,37
	RDRGRD110I	110x110x90	16		14	L	58,77



1° size: female solvent cement
2° size: male solvent cement
3° size: female solvent cement

1° misura: incollaggio femmina
2° misura: incollaggio maschio
3° misura: incollaggio femmina

Reduced elbow 45° plain / Coude réduit 45° / Winkel 45° reduziert / Gomito ridotto a 45° / Codo 45° reducido

	Code / Codice	d	PN / PFA	Q.tà min / Min. q.ty	Box	Pack / Imballo	€
GRY	RDRGRY032C	32 x 32 x 25	16	10	200	M	5,72
	RDRGRY040D	40 x 40 x 32	16		150	M	7,31
	RDRGRY050E	50 x 50 x 40	16		150	L	8,01
	RDRGRY063F	63 x 63 x 50	16		90	L	12,42
	RDRGRY075G	75 x 75 x 63	16		50	L	21,67



1° size: female solvent cement
2° size: male solvent cement
3° size: female solvent cement

1° misura: incollaggio femmina
2° misura: incollaggio maschio
3° misura: incollaggio femmina

Socket / Manchon / Muffe / Manicotto / Manguito

	Code / Codice	d	PN / PFA	Q.tà min / Min. q.ty	Box	Pack / Imballo	€
MAD 	RDRMAD0160	16	16	10	500	S	0,99
	RDRMAD0200	20	16	10	350	S	0,99
	RDRMAD0250	25	16	10	400	M	0,99
	RDRMAD0320	32	16	10	250	M	1,04
	RDRMAD0400	40	16		180	M	1,69
	RDRMAD0500	50	16		200	L	2,06
	RDRMAD0630	63	16		100	L	2,90
	RDRMAD0750	75	16		80	L	7,06
	RDRMAD0900	90	16		45	L	11,01
	RDRMAD1100	110	16		27	L	15,45
	RDRMAD1250	125	16		20	L	23,30
	RDRMAD1400	140	16		12	L	30,37
	RDRMAD1600	160	16		6	L	36,22
	RDRMAD1800	180	10		2	L	On request
	RDRMAD2000	200	10		3	L	88,44
	RDRMAD2250	225	10		2	L	107,12
	RDRMAD2500	250	10		1	L	189,95
	RDRMAD2800	280	10		1	L	243,38
	RDRMAD3150	315	10		1	L	265,98
	RDRMAD3550	355	5		1	L	On request
RDRMAD4000	400	5		1	L	On request	

Male socket / Manchon male / Muffe männlich / Manicotto maschio / Manguito macho

	Code / Codice	d	L (mm)	PN / PFA	Q.tà min / Min. q.ty	Box	Pack / Imballo	€
MAM 	RDRMAM0200	20	34	16	10	350	S	1,06
	RDRMAM0250	25	40	16	10	400	M	0,98
	RDRMAM0320	32	46	16	10	250	M	1,07
	RDRMAM0400	40	52	16		180	M	2,04
	RDRMAM0500	50	65	16		200	L	2,88
	RDRMAM0630	63	79	16		100	L	3,29

TEE 90° / Té 90° / T-Stück 90° / Ti a 90° / Te 90°

	Code / Codice	d	PN / PFA	Q.tà min / Min. q.ty	Box	Pack / Imballo	€
TID 	RDRTID0160	16	16	10	300	S	1,20
	RDRTID0200	20	16	10	400	M	1,22
	RDRTID0250	25	16	10	200	M	1,48
	RDRTID0320	32	16	5	100	M	2,16
	RDRTID0400	40	16		70	M	3,50
	RDRTID0500	50	16		80	L	4,08
	RDRTID0630	63	16		50	L	6,24
	RDRTID0750	75	16		32	L	12,53
	RDRTID0900	90	16		20	L	17,52
	RDRTID1100	110	16		10	L	29,61
	RDRTID1250	125	16		7	L	56,80
	RDRTID1400	140	16		4	L	77,25
	RDRTID1600	160	16		3	L	94,22
	RDRTID2000	200	10		1	L	176,80
	RDRTID2250	225	10		1	L	231,90
	RDRTID2500	250	10		1	L	342,33
	RDRTID2800	280	10		1	L	551,98
	RDRTID3150	315	10		1	L	668,44
	RDRTID3550	355	4		1	L	On request
	RDRTID4000	400	4		1	L	On request

Cap / Bouchon / Kappe / Calotta / Tapón rosca hembra

	Code / Codice	d	PN / PFA	Q.tà min / Min. q.ty	Box	Pack / Imballo	€
CAD 	RDRCAD0160	16	16	10	500	S	1,01
	RDRCAD0200	20	16	10	500	S	1,01
	RDRCAD0250	25	16	10	350	S	1,09
	RDRCAD0320	32	16	10	400	M	1,29
	RDRCAD0400	40	16		250	M	1,80
	RDRCAD0500	50	16		180	M	2,27
	RDRCAD0630	63	16		100	M	3,08
	RDRCAD0750	75	16		60	M	6,94
	RDRCAD0900	90	16		65	L	9,67
	RDRCAD1100	110	16		40	L	13,66
	RDRCAD1250	125	16		33	L	23,84
	RDRCAD1400	140	16		20	L	25,14
	RDRCAD1600	160	16		12	L	34,88
	RDRCAD2000	200	10		6	L	82,64
	RDRCAD2250	225	10		6	L	130,99
	RDRCAD2500	250	10		5	L	246,49
	RDRCAD3150	315	10		1	L	449,02

Bend 90° / Courbe 90° / Bogen 90° / Curva a 90° / Curva 90°

	Code / Codice	d	PN / PFA	Q.tà min / Min. q.ty	Box	Pack / Imballo	€
	RDRUD0200	20	16	10	300	M	4,95
	RDRUD0250	25	16	10	150	M	5,66
	RDRUD0320	32	16	10	100	M	7,33
	RDRUD0400	40	16		50	M	10,11
	RDRUD0500	50	16		60	L	13,91
	RDRUD0630	63	16		30	L	18,45
	RDRUD0750	75	16		15	L	40,84
	RDRUD0900	90	16		9	L	51,04
	RDRUD1100	110	16		6	L	82,26

Tee 45° / Té 45° / T-Stück 45° / Ti a 45° / Te 45°

	Code / Codice	d	PN / PFA	Q.tà min / Min. q.ty	Box	Pack / Imballo	€
	RDRTYD0200	20	16	10	150	S	5,07
	RDRTYD0250	25	16	10	70	S	5,31
	RDRTYD0320	32	16	5	90	M	5,95
	RDRTYD0400	40	16		50	M	8,09
	RDRTYD0500	50	16		35	M	10,55
	RDRTYD0630	63	16		18	M	14,54
	RDRTYD0750	75	16		12	M	61,94
	RDRTYD0900	90	10		12	L	94,47
	RDRTYD1100	110	10		8	L	193,74
	RDRTYD1600	160	10		1	L	On request

Reducing piece / Réduction double / Reduktion lang / Riduzione lunga / Reducción larga

	Code / Codice	d	PN / PFA	Q.tà min / Min. q.ty	Box	Pack / Imballo	€
	RDRRLD020A	20 x 25 x 16	16	10	500	S	1,12
	RDRRLD020B	20 x 25 x 20	16	10	500	S	1,12
	RDRRLD025A	25 x 32 x 16	16	10	300	S	1,21
	RDRRLD025B	25 x 32 x 20	16	10	300	S	1,21
	RDRRLD025C	25 x 32 x 25	16	10	280	S	1,21
	RDRRLD032B	32 x 40 x 20	16		170	S	1,55
	RDRRLD032C	32 x 40 x 25	16		170	S	1,55
	RDRRLD032D	32 x 40 x 32	16		350	M	1,55
	RDRRLD040C	40 x 50 x 25	16		200	M	2,05
	RDRRLD040D	40 x 50 x 32	16		200	M	2,05
	RDRRLD040E	40 x 50 x 40	16		200	M	2,05
	RDRRLD050D	50 x 63 x 32	16		125	M	2,83
	RDRRLD050E	50 x 63 x 40	16		120	M	2,83
	RDRRLD050F	50 x 63 x 50	16		100	M	2,99
	RDRRLD063E	63 x 75 x 40	16		80	M	3,80
	RDRRLD063F	63 x 75 x 50	16		80	M	3,80
	RDRRLD063G	63 x 75 x 63	16		60	M	5,71
	RDRRLD075F	75 x 90 x 50	16		45	M	8,11
	RDRRLD075G	75 x 90 x 63	16		36	M	8,11
	RDRRLD075H	75 x 90 x 75	16		36	M	9,66
	RDRRLD090F	90 x 110 x 50	16		45	L	11,50
	RDRRLD090G	90 x 110 x 63	16		45	L	11,50
	RDRRLD090H	90 x 110 x 75	16		45	L	11,50
	RDRRLD090I	90 x 110 x 90	16		45	L	13,19
	RDRRLD110G	110 x 125 x 63	16		42	L	17,41
	RDRRLD110H	110 x 125 x 75	16		42	L	17,41
	RDRRLD110I	110 x 125 x 90	16		42	L	17,41
	RDRRLD110L	110 x 125 x 110	16		42	L	18,42
	RDRRLD125I	125 x 140 x 90	16		30	L	27,62
	RDRRLD125L	125 x 140 x 110	16		20	L	27,62
	RDRRLD125M	125 x 140 x 125	16		20	L	27,62
	RDRRLD140I	140 x 160 x 90	16		16	L	41,71
	RDRRLD140L	140 x 160 x 110	16		16	L	43,53
	RDRRLD140M	140 x 160 x 125	16		12	L	57,63
	RDRRLD160N	160 - x 140	16		6	L	122,47
	RDRRLD200L	200 x 110	10		1	L	142,12
	RDRRLD200N	200 x 140	10		1	L	142,12
	RDRRLD200O	200 - x 160	10		4	L	137,04
	RDRRLD225Q	225 X 200	10		1	L	192,91
	RDRRLD250Q	250 x 200	10		1	L	219,32
RDRRLD250R	250 x 225	10		1	L	219,32	
RDRRLD315S	315 x 250	8		1	L	290,31	

1° size: female
2° size: male
3° size: female

1° misura: incollaggio femmina
2° misura: incollaggio maschio
3° misura: incollaggio femmina

Cross / Croix / Kreuz / Croce / Cruz

CRD



Code / Codice	d	PN / PFA	Q.tà min / Min. q.ty	Box	Pack / Imballo	€
RDRCRD0200	20	16	10	200	S	4,15
RDRCRD0250	25	16	10	100	S	5,22
RDRCRD0320	32	16	10	100	M	6,22
RDRCRD0400	40	16		60	M	9,14
RDRCRD0500	50	16		35	M	11,31
RDRCRD0630	63	16		20	M	16,89
RDRCRD0750	75	16		10	M	60,29
RDRCRD0900	90	16		12	L	84,51
RDRCRD1100	110	16		7	L	106,25

90° Tee Reduced / Tè 90° Réduit / T-Stück 90° reduziert / Ti a 90° ridotto / Te 90° Reducido

TRD



Code / Codice	d	PN / PFA	Q.tà min / Min. q.ty	Box	Pack / Imballo	€
RDRTRD020A	20 x 16	16	10	180	S	1,40
RDRTRD025A	25 x 16	16	10	220	M	1,61
RDRTRD025B	25 x 20	16	10	220	M	1,61
RDRTRD032A	32 x 16	16	5	160	M	2,21
RDRTRD032B	32 x 20	16	5	120	M	2,21
RDRTRD032C	32 x 25	16	5	120	M	2,16
RDRTRD040B	40 x 20	16		100	M	2,97
RDRTRD040C	40 x 25	16		90	M	2,97
RDRTRD040D	40 x 32	16		90	M	2,97
RDRTRD050B	50 x 20	16		110	L	4,79
RDRTRD050C	50 x 25	16		110	L	4,79
RDRTRD050D	50 x 32	16		110	L	4,79
RDRTRD050E	50 x 40	16		100	L	4,79
RDRTRD063C	63 x 25	16		60	L	7,39
RDRTRD063D	63 x 32	16		60	L	7,39
RDRTRD063E	63 x 40	16		60	L	7,39
RDRTRD063F	63 x 50	16		60	L	7,39
RDRTRD075E	75 x 40	16		32	L	12,60
RDRTRD075F	75 x 50	16		32	L	12,60
RDRTRD075G	75 x 63	16		32	L	12,60
RDRTRD090E	90 x 40	16		24	L	17,85
RDRTRD090F	90 x 50	16		22	L	17,85
RDRTRD090G	90 x 63	16		22	L	17,85
RDRTRD090H	90 x 75	16		12	L	17,66
RDRTRD110F	110 x 50	16		12	L	30,27
RDRTRD110G	110 x 63	16		10	L	30,27
RDRTRD110H	110 x 75	16		12	L	30,27
RDRTRD110I	110 x 90	16		10	L	30,27
RDRTRD125G	125 x 63	16		8	L	66,28
RDRTRD125H	125 x 75	16		8	L	66,28
RDRTRD125I	125 x 90	16		8	L	66,28
RDRTRD125L	125 x 110	16		8	L	66,28
RDRTRD140I	140 x 90	16		4	L	91,09
RDRTRD140L	140 x 110	16		4	L	97,96
RDRTRD140M	140 x 125	16		4	L	97,96
RDRTRD160I	160 x 90	16		3	L	114,60
RDRTRD160L	160 x 110	16		3	L	114,60
RDRTRD160M	160 x 125	16		3	L	114,60
RDRTRD160N	160 x 140	16		3	L	114,60
RDRTRD200L	200 x 110	10		1	L	227,11
RDRTRD200O	200 x 160	10		2	L	269,30
RDRTRD250O	250 x 160	10		1	L	568,58
RDRTRD250Q	250 x 200	10		1	L	574,10
RDRTRD315O	315 x 160	8		1	L	700,24
RDRTRD315S	315 x 250	8		1	L	700,24
RDRTRD400U	400 x 315	4		1	L	On request

Fixed Flange / Bride collet / Festflansch / Flangia fissa / Brida fija

FFD



Code / Codice	d	DN	PN / PFA	Q.tà min / Min. q.ty	Box	Pack / Imballo	€
RDRFFD0200	20	15	16	10	100	S	4,49
RDRFFD0250	25	20	16	10	60	S	5,95
RDRFFD0320	32	25	16	10	50	S	6,98
RDRFFD0400	40	32	16		50	M	9,16
RDRFFD0500	50	40	16		48	M	10,70
RDRFFD0630	63	50	16		36	M	12,30
RDRFFD0750	75	65	16		15	M	14,80
RDRFFD0900	90	80	16		10	M	17,60
RDRFFD1100	110	100	16		20	L	22,72

Blank Flange / Bride d'optutation / Blindflansch / Flangia cieca / Brida Ciega

	Code / Codice	d	DN	PN / PFA	Q.tà min / Min. q.ty	Box	Pack / Imballo	€
FCD 	RDRFCD0200	20	15	16	10	150	S	4,56
	RDRFCD0250	25	20	16	10	80	S	5,21
	RDRFCD0320	32	25	16	10	65	S	6,94
	RDRFCD0400	40	32	16		70	M	8,96
	RDRFCD0500	50	40	16		65	M	10,59
	RDRFCD0630	63	50	16		40	M	12,37
	RDRFCD0750	75	65	16		35	M	13,96
	RDRFCD0900	90	80	16		30	M	16,28
	RDRFCD1100	110	100	16		20	M	21,06
	RDRFCD1250	125	110	16		18	M	28,88
	RDRFCD1400	140	125	16		15	M	34,07
	RDRFCD1600	160	150	16		10	M	36,97
	RDRFCD2000	200	200	10		10	L	132,19
	RDRFCD2250	225	200	10		10	L	140,10
	RDRFCD2500	250	225	8		1	L	199,79
	RDRFCD3150	315	300	6		1	L	401,39
	RDRFCD4000	400	350	4		1	L	On request

Loose flange / Bride libre / Losflansch / Flangia libera / Brida loca

	Code / Codice	d	DN	PN / PFA	Q.tà min / Min. q.ty	Box	Pack / Imballo	€
FLD 	RDRFLD0200	20	15	16	10	150	S	3,74
	RDRFLD0250	25	20	16	10	100	S	4,09
	RDRFLD0320	32	25	16	10	150	M	4,73
	RDRFLD0400	40	32	16		100	M	6,68
	RDRFLD0500	50	40	16		80	M	7,20
	RDRFLD0630	63	50	16		50	M	7,76
	RDRFLD0750	75	65	16		40	M	9,84
	RDRFLD0900	90	80	16		35	M	11,04
	RDRFLD1100	110	100	16		24	M	13,78
	RDRFLD1250	125	110	16		20	M	20,06
	RDRFLD1400	140	125	16		18	M	23,42
	RDRFLD1600	160	150	16		20	L	26,56
	RDRFLD2000	200	200	10		10	L	58,33
	RDRFLD2250	225	200	10		10	L	64,52
	RDRFLD2500	250	225	10		6	L	93,19
	RDRFLD2800	280	250	10		1	L	141,81
	RDRFLD3150	315	300	10		1	L	159,52
RDRFLD3550	355	300	4		1	L	On request	
RDRFLD4000	400	350	4		1	L	On request	

Stub Serrated / Collet strié / Bundbuchse gerillt / Collare rigato per flange / Manguito portabridas

	Code / Codice	d	PN / PFA	Q.tà min / Min. q.ty	Box	Pack / Imballo	€
QRD 	RDRQRD0200	20	16	10	600	S	1,03
	RDRQRD0250	25	16	10	300	S	1,16
	RDRQRD0320	32	16	10	200	S	1,20
	RDRQRD0400	40	16		200	M	1,78
	RDRQRD0500	50	16		180	M	2,75
	RDRQRD0630	63	16		90	M	4,40
	RDRQRD0750	75	16		100	L	7,01
	RDRQRD0900	90	16		70	L	8,49
	RDRQRD1100	110	16		40	L	11,12
	RDRQRD1250	125	16		25	L	24,00
	RDRQRD1400	140	16		20	L	26,12
	RDRQRD1600	160	16		15	L	28,85
	RDRQRD2000	200	10		7	L	55,63
	RDRQRD2250	225	10		4	L	68,45
	RDRQRD2500	250	10		4	L	76,62
	RDRQRD2800	280	10		1	L	138,99
	RDRQRD3150	315	10		1	L	182,87
RDRQRD3550	355	4		1	L	On request	
RDRQRD4000	400	4		1	L	On request	

Flat Gaskets for QRD / Joint plât pour QRD / Flachdichtung für QRD / Guarnizione piana per QRD / Junta plana para QRD

	Code / Codice	d	PN / PFA	Q.tà min / Min. q.ty	Box	Pack / Imballo	€
GQP EPDM	RGRGQP0200	20					0,76
	RGRGQP0250	25					0,90
	RGRGQP0320	32					0,90
	RGRGQP0400	40					1,08
	RGRGQP0500	50					1,45
	RGRGQP0630	63					1,62
	RGRGQP0750	75					2,08
	RGRGQP0900	90					2,49
	RGRGQP1100	110					3,47
	RGRGQP1250	125					4,70
	RGRGQP1400	140					5,19
	RGRGQP1600	160					5,93
	RGRGQP2000	200					9,27
	RGRGQP2250	225					11,66
	RGRGQP2500	250					21,61
	RGRGQP2800	280					35,54
	RGRGQP3150	315					46,32



Reducing Bush / Réduction courte / Reduktion kurz / Riduzione corta / Reducción corta

	Code / Codice	d	PN / PFA	Q.tà min / Min. q.ty	Box	Pack / Imballo	€
RCD	RDRRCD020A	20 x 16	16	10	1000	S	0,76
	RDRRCD025A	25 x 16	16	10	700	S	0,80
	RDRRCD025B	25 x 20	16	10	700	S	0,80
	RDRRCD032A	32 x 16	16	10	450	S	1,12
	RDRRCD032B	32 x 20	16	10	450	S	1,12
	RDRRCD032C	32 x 25	16	10	450	S	1,10
	RDRRCD040B	40 x 20	16		250	S	1,24
	RDRRCD040C	40 x 25	16		250	S	1,24
	RDRRCD040D	40 x 32	16		250	S	1,24
	RDRRCD050C	50 x 25	16		350	M	1,46
	RDRRCD050D	50 x 32	16		350	M	1,46
	RDRRCD050E	50 x 40	16		350	M	1,46
	RDRRCD063D	63 x 32	16		180	M	1,99
	RDRRCD063E	63 x 40	16		180	M	1,99
	RDRRCD063F	63 x 50	16		180	M	1,99
	RDRRCD075E	75 x 40	16		110	M	3,68
	RDRRCD075F	75 x 50	16		110	M	3,68
	RDRRCD075G	75 x 63	16		110	M	3,68
	RDRRCD090F	90 x 50	16		65	M	5,98
	RDRRCD090G	90 x 63	16		65	M	5,98
	RDRRCD090H	90 x 75	16		65	M	5,98
	RDRRCD110G	110 x 63	16		40	M	8,28
	RDRRCD110H	110 x 75	16		40	M	8,28
	RDRRCD110I	110 x 90	16		40	M	8,28
	RDRRCD125H	125 x 75	16		50	L	15,84
	RDRRCD125I	125 x 90	16		50	L	15,84
	RDRRCD125L	125 x 110	16		50	L	15,84
	RDRRCD140I	140 x 90	16		40	L	22,85
	RDRRCD140L	140 x 110	16		40	L	22,85
	RDRRCD140M	140 x 125	16		40	L	22,85
	RDRRCD160I	160 x 90	16		24	L	24,77
	RDRRCD160L	160 x 110	16		24	L	24,77
	RDRRCD160M	160 x 125	16		24	L	24,77
	RDRRCD160N	160 x 140	16		24	L	24,77
	RDRRCD200O	200 x 160	10		10	L	47,21
	RDRRCD200P	200 x 180	10		12	L	48,45
	RDRRCD225O	225 x 160	10		7	L	58,99
	RDRRCD225Q	225 x 200	10		7	L	61,04
	RDRRCD250O	250 x 160	10		6	L	117,39
	RDRRCD250Q	250 x 200	10		6	L	117,39
	RDRRCD250R	250 x 225	10		6	L	117,39
	RDRRCD280R	280 x 225	10		4	L	180,15
	RDRRCD280S	280 x 250	10		5	L	181,90
RDRRCD315Q	315 x 200	10		5	XL	196,02	
RDRRCD315R	315 x 225	10		5	XL	196,02	
RDRRCD315S	315 x 250	10		5	XL	196,02	
RDRRCD315T	315 x 280	10		5	XL	196,02	
RDRRCD355U	355 x 315	5		1	XL	On request	
RDRRCD400U	400 x 315	5		1	XL	On request	
RDRRCD400V	400 x 355	5		1	XL	On request	

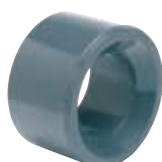

Unions / Union 3 Pièces / Verschraubungen Bocchettoni / Unión

Union with O-ring / Union 3 pièces / Verschraubung 3 Stk. / Bocchettone con O-Ring / Unión

	Code / Codice	d	PN / PFA	Q.tà min / Min. q.ty	Box	Pack / Imballo	€
BOD* EPDM	RDRBOD0160	16	16	10	200	S	4,05
	RDRBOD0200	20	16	10	150	S	4,05
	RDRBOD0250	25	16	10	200	M	4,64
	RDRBOD0320	32	16	5	120	M	5,06
	RDRBOD0400	40	16		80	M	7,52
	RDRBOD0500	50	16		60	M	9,68
	RDRBOD0630	63	16		30	M	12,85
	RDRBOD0750	75	16		30	L	35,98
	RDRBOD0900	90	16		25	L	42,19
	RDRBOD1100	110	16		15	L	48,83



Union MM/BSP / Union 3 pièces MM/BSP / Verschraubung 3 Stk. MM/BSP / Bocchettone MM/BSP / Unión MM/BSP

	Code / Codice	d x Rp (UNI EN 10226)	PN / PFA	Q.tà min / Min. q.ty	Box	Pack / Imballo	€
BOG* EPDM	RGRBOG016A	16 x 3/8"	16	10	200	S	5,13
	RGRBOG020B	20 x 1/2"	16	10	150	S	5,13
	RGRBOG025C	25 x 3/4"	16	10	200	M	5,90
	RGRBOG032D	32 x 1"	16	5	120	M	7,69
	RGRBOG040E	40 x 1 1/4"	16		80	M	9,17
	RGRBOG050F	50 x 1 1/2"	16		60	M	12,64
	RGRBOG063G	63 x 2"	16		30	M	16,17
	RGRBOG075H	75 x 2 1/2"	16		30	L	44,22
	RGRBOG090I	90 x 3"	16		25	L	51,70
	RGRBOG110L	110 x 4"	16		15	L	59,74



Union BSP / Union 3 pièces BSP / Verschraubung 3 Stk. BSP / Bocchettone BSP / Unión BSP

	Code / Codice	Rp (UNI EN 10226)	PN / PFA	Q.tà min / Min. q.ty	Box	Pack / Imballo	€
BOE* EPDM	REBBOE016A	3/8"	16	10	300	S	6,26
	REBBOE020B	1/2"	16	10	150	S	5,16
	REBBOE025C	3/4"	16	10	200	M	6,12
	REBBOE032D	1"	16	5	120	M	6,90
	REBBOE040E	1 1/4"	16		80	M	8,57
	REBBOE050F	1 1/2"	16		60	M	11,80
	REBBOE063G	2"	16		30	M	16,20
	REBBOE075H	2 1/2"	16		30	L	45,75
	REBBOE090I	3"	16		25	L	53,07
	REBBOE110L	4"	16		15	L	61,19



Union Plain BS / Union 3 Pièces BS / Verschraubung 3 Stk. BS / Bocchettone BS / Unión BS

	Code / Codice	d	PN / PFA	Q.tà min / Min. q.ty	Box	Pack / Imballo	€
BOA* EPDM	RARBOA0160	3/8"	15	10	200	S	3,41
	RARBOA0200	1/2"	15	10	150	S	3,41
	RARBOA0250	3/4"	15	10	200	M	3,83
	RARBOA0320	1"	15	5	120	M	5,06
	RARBOA0400	1 1/4"	15		80	M	6,64
	RARBOA0500	1 1/2"	15		60	L	8,39
	RARBOA0630	2"	15		30	L	11,82
	RARBOA0750	2 1/2"	15		30	L	35,98
	RARBOA0900	3"	15		25	L	42,19
	RARBOA1100	4"	15		15	L	48,83



Union BS/BSP / Union 3 Pièces BS/BSP / Verschraubung 3 Stk. BS/BSP / Bocchettone BS/BSP / Unión BS/BSP

	Code / Codice	d x Rp (UNI EN 10226)	PN / PFA	Q.tà min / Min. q.ty	Box	Pack / Imballo	€
BOC* EPDM	RCRBOC020B	1/2" x 1/2"	15	10	150	S	5,18
	RCRBOC025C	3/4" x 3/4"	15	10	200	M	5,96
	RCRBOC032D	1" x 1"	15	5	120	M	7,92
	RCRBOC040E	1 1/4" x 1 1/4"	15		80	M	9,26
	RCRBOC050F	1 1/2" x 1 1/2"	15		60	M	13,01
	RCRBOC063G	2" x 2"	15		30	M	16,65
	RCRBOC075H	2 1/2" x 2 1/2"	15		30	L	44,65
	RCRBOC090I	3" x 3"	15		25	L	52,20
	RCRBOC110L	4" x 4"	15		15	L	60,32



*Available also with FKM seals on request / *Disponibile anche con guarnizioni in FKM a richiesta

Union BSP/BS / Union BSP/BS / Verschraubung BSP/BS / Bocchettone BSP/BS / Unión BSP/BS

	Code / Codice	d x Rp (UNI EN 10226)	PN / PFA	Q.tà min / Min. q.ty	Box	Pack / Imballo	€
BMC 	RCRBMC020B	1/2" x 1/2	15	10	150	S	5,06
	RCRBMC025C	3/4" x 3/4	15	10	200	M	5,48
	RCRBMC032D	1" x 1	15	5	120	M	5,91
	RCRBMC040E	1 1/4" x 1 1/4	15		80	M	7,87
	RCRBMC050F	1 1/2" x 1 1/2	15		60	M	9,50
	RCRBMC063G	2" x 2	15		30	M	12,94

Union BSP / Union BSP / Verschraubung BSP / Bocchettone BSP / Unión BSP

	Code / Codice	Rp (UNI EN 10226)	PN / PFA	Q.tà min / Min. q.ty	Box	Pack / Imballo	€
BME 	REBME020B	1/2"	16	10	150	S	5,20
	REBME025C	3/4"	16	10	200	M	5,56
	REBME032D	1"	16	5	120	M	5,98
	REBME040E	1 1/4"	16		80	M	7,67
	REBME050F	1 1/2"	16		50	M	9,50
	REBME063G	2"	16		30	M	14,20

Union with cap / Union 3 pièces avec Bouchon / Verschraubung 3 Stk. mit Kappe / Bocchettone con tappo / Unión con tapon

	Code / Codice	d	PN / PFA	Q.tà min / Min. q.ty	Box	Pack / Imballo	€
BOT 	RDRBOT0200	20	16	10	150	S	5,31
	RDRBOT0250	25	16	10	200	M	5,47
	RDRBOT0320	32	16	5	120	M	6,64
	RDRBOT0400	40	16		80	M	9,84
	RDRBOT0500	50	16		60	M	9,14
	RDRBOT0630	63	16		30	M	12,03

Union adaptor F/M/F / Adapteur union 3 pièces F/M/F / Übergangverschraubung AG/IG/AG / Bocchettone adattatore incollaggio metrico F/M/F / Adaptor unión M/H/M

	Code / Codice	d	PN / PFA	Q.tà min / Min. q.ty	Box	Pack / Imballo	€
BOP 	RDRBOP020B	20 x 25 x 20	16	10	150	S	5,54
	RDRBOP025C	25 x 32 x 25	16	10	200	M	6,12
	RDRBOP032D	32 x 40 x 32	16	5	120	M	6,87
	RDRBOP040E	40 x 50 x 40	16		80	M	9,02
	RDRBOP050F	50 x 63 x 50	16		60	L	10,50
	RDRBOP063G	63 x 75 x 63	16		30	L	14,72

1° size: female solvent cement
2° size: male solvent cement
3° size: female solvent cement

Adaptor Union Socket Plain/Male Threaded / Manchon 3 P fil. mâle / Verschraubung AG / Bocchettone 3 P fil. maschio / Unión Rosca Macho

	Code / Codice	d x R(UNI EN 10226)	PN / PFA	Q.tà min / Min. q.ty	Box	Pack / Imballo	€
BMG 	RGRBMG020B	20 x 1/2"	16	10	100	S	5,23
	RGRBMG025C	25 x 3/4"	16	10	150	M	5,86
	RGRBMG032D	32 x 1"	16	5	100	M	7,34
	RGRBMG040E	40 x 1 1/4"	16		50	M	8,55
	RGRBMG050F	50 x 1 1/2"	16		60	M	12,93
	RGRBMG050G	50 x 2"	16		30	M	14,93
	RGRBMG063G	63 x 2"	16		30	M	16,49

Union adaptor plain female male with cap / Union 3 pièces F/M avec bouchon / Verschraubung IG/AG mit Stopfen / Bocchettone adattatore incollaggio femmina maschio con tappo / Unión M/H con tapon

	Code / Codice	d	PN / PFA	Q.tà min / Min. q.ty	Box	Pack / Imballo	€
BAT* EPDM 	RDRBAT0200	20 x 25	16	10	150	S	5,78
	RDRBAT0250	25 x 32	16	10	200	M	6,21
	RDRBAT0320	32 x 40	16	5	120	M	7,00
	RDRBAT0400	40 x 50	16		80	M	9,31
	RDRBAT0500	50 x 63	16		60	L	10,70
	RDRBAT0630	63 x 75	16		30	L	14,89

1° size: female solvent cement
2° size: male solvent cement

*Available also with FKM seals on request / *Disponibile anche con guarnizioni in FKM a richiesta

Adaptor Fittings / Raccordi d'Adaptation / Übergangsfittings Raccordi di Passaggio / Accesorios Mixto Encolar

Elbow 90° / Coude 90° / Winkel 90° / Gomito 90° / Codo 90°

GOG



Code / Codice	d x Rp (UNI EN 10226)	PN / PFA	Q.tà min / Min. q.ty	Box	Pack / Imballo	€
RGRGOG016A	16 x 3/8"	16	10	350	S	1,53
RGRGOG020B	20 x 1/2"	16	10	250	S	1,69
RGRGOG025C	25 x 3/4"	16	10	300	M	1,97
RGRGOG032D	32 x 1"	16	10	180	M	2,25
RGRGOG040E	40 x 1 1/4"	16		120	M	4,52
RGRGOG050F	50 x 1 1/2"	16		120	L	6,14
RGRGOG063G	63 x 2"	16		60	L	8,40
RGRGOG075H	75 x 2 1/2"	16		40	L	17,66
RGRGOG090I	90 x 3"	16		25	L	25,77
RGRGOG110L	110 x 4"	16		14	L	39,80

Tee 90° / Té 90° / T-stück 90° / Ti 90° / Te 90°

TIG



Code / Codice	d x Rp (UNI EN 10226)	PN / PFA	Q.tà min / Min. q.ty	Box	Pack / Imballo	€
RGRTIG016A	16 x 3/8"	16	10	300	S	1,96
RGRTIG020B	20 x 1/2"	16	10	400	M	2,27
RGRTIG025C	25 x 3/4"	16	10	200	M	2,50
RGRTIG032D	32 x 1"	16	10	100	M	3,73
RGRTIG040E	40 x 1 1/4"	16		70	M	4,16
RGRTIG050F	50 x 1 1/2"	16		80	L	6,21
RGRTIG063G	63 x 2"	16		50	L	11,04
RGRTIG075H	75 x 2 1/2"	16		32	L	20,19
RGRTIG090I	90 x 3"	16		20	L	28,00
RGRTIG110L	110 x 4"	16		10	L	45,75

Socket / Manchon / Muffe / Manicotto / Manguito

MAG



Code / Codice	d x Rp (UNI EN 10226)	PN / PFA	Q.tà min / Min. q.ty	Box	Pack / Imballo	€
RGRMAG016A	16 x 3/8"	16	10	450	S	1,79
RGRMAG020B	20 x 1/2"	16	10	350	S	1,79
RGRMAG025C	25 x 3/4"	16	10	450	M	1,92
RGRMAG032D	32 x 1"	16	10	250	M	2,16
RGRMAG040E	40 x 1 1/4"	16		180	M	2,74
RGRMAG050F	50 x 1 1/2"	16		120	M	4,08
RGRMAG063G	63 x 2"	16		75	M	6,13
RGRMAG075H	75 x 2 1/2"	16		36	M	16,25
RGRMAG090I	90 x 3"	16		45	M	17,66
RGRMAG110L	110 x 4"	16		30	L	25,84
RGRMAG125M	125 x 5"	10		10	L	49,87

Adaptor female threaded / Embout femelle / Übergangsnippel IG / Adattatore con filetto femmina / Adaptator rosca hembra

AFG



1° size: male solvent cement
2° size: female threaded

1° misura: incollaggio maschio
2° misura: filettato femmina

Code / Codice	d x Rp (UNI EN 10226)	PN / PFA	Q.tà min / Min. q.ty	Box	Pack / Imballo	€
RGRAFG016A	16 x 3/8"	16	10	600	S	1,93
RGRAFG020B	20 x 1/2"	16	10	350	S	2,17
RGRAFG020C	20 x 3/4"	16	10	300	S	2,38
RGRAFG025B	25 x 1/2"	16	10	500	M	2,38
RGRAFG025C	25 x 3/4"	16	10	450	M	2,51
RGRAFG025D	25 x 1"	16	10	350	M	2,61
RGRAFG032C	32 x 3/4"	16	10	250	M	2,61
RGRAFG032D	32 x 1"	16	10	250	M	2,96
RGRAFG040D	40 x 1"	16		200	M	3,11
RGRAFG040E	40 x 1 1/4"	16		180	M	3,27
RGRAFG050E	50 x 1 1/4"	16		140	M	3,67
RGRAFG050F	50 x 1 1/2"	16		110	M	3,99
RGRAFG050G	50 x 2"	16		110	M	5,50
RGRAFG063G	63 x 2"	16		70	M	6,86
RGRAFG075G	75 x 2"	16		60	M	8,81
RGRAFG075H	75 x 2 1/2"	16		80	L	12,48
RGRAFG075I	75 x 3"	16		35	M	13,66
RGRAFG090H	90 x 2 1/2"	16		45	L	13,66
RGRAFG090I	90 x 3"	16		45	L	15,44
RGRAFG090L	90 x 4"	16		35	L	19,19
RGRAFG110I	110 x 3"	16		30	L	19,19
RGRAFG110L	110 x 4"	16		30	L	22,06

*Available also with FKM seals on request / *Disponibile anche con guarnizioni in FKM a richiesta

Adaptor Male Threaded / Embout mâle / Übergangsmuffennippel AG / Adattatore con filetto maschio / Adaptador rosca macho

	Code / Codice	d x d x R (UNI EN 10226)	PN / PFA	Q.tà min / Min. q.ty	Box	Pack / Imballo	€
AMG  1° size: female solvent cement 2° size: male solvent cement 3° size: male threaded 1° misura: incollaggio femmina 2° misura: incollaggio maschio 3° misura: filettato maschio	RGRAMG012A	12 x 16 x 3/8"	16	10	1000	S	1,09
	RGRAMG016A	16 x 20 x 3/8"	16	10	500	S	1,09
	RGRAMG016B	16 x 20 x 1/2"	16	10	450	S	1,09
	RGRAMG020A	20 x 25 x 3/8"	16	10	300	S	1,16
	RGRAMG020B	20 x 25 x 1/2"	16	10	300	S	1,16
	RGRAMG020C	20 x 25 x 3/4"	16	10	250	S	1,16
	RGRAMG025B	25 x 32 x 1/2"	16	10	400	M	1,30
	RGRAMG025C	25 x 32 x 3/4"	16	10	400	M	1,30
	RGRAMG025D	25 x 32 x 1"	16	10	350	M	1,37
	RGRAMG032C	32 x 40 x 3/4"	16		300	M	1,62
	RGRAMG032B	32 x 40 x 1/2"	16		300	M	1,65
	RGRAMG032D	32 x 40 x 1"	16		250	M	1,62
	RGRAMG032E	32 x 40 x 1 1/4"	16		200	M	1,89
	RGRAMG040D	40 x 50 x 1"	16		160	M	2,38
	RGRAMG040E	40 x 50 x 1 1/4"	16		150	M	2,38
	RGRAMG040F	40 x 50 x 1 1/2"	16		140	M	2,74
	RGRAMG050E	50 x 63 x 1 1/4"	16		120	M	3,61
	RGRAMG050F	50 x 63 x 1 1/2"	16		120	M	3,61
	RGRAMG050G	50 x 63 x 2"	16		100	M	3,61
	RGRAMG063F	63 x 75 x 1 1/2"	16		70	M	4,81
	RGRAMG063G	63 x 75 x 2"	16		70	M	4,81
	RGRAMG063H	63 x 75 x 2 1/2"	16		50	M	9,61
	RGRAMG075G	75 x 90 x 2"	16		45	M	11,32
	RGRAMG075H	75 x 90 x 2 1/2"	16		45	M	12,58
	RGRAMG075I	75 x 90 x 3"	16		60	L	13,15
	RGRAMG090H	90 x 110 x 2 1/2"	16		45	L	15,44
	RGRAMG090I	90 x 110 x 3"	16		45	L	15,14
	RGRAMG090L	90 x 110 x 4"	16		30	L	19,29
	RGRAMG110I	110 x 125 x 3"	16		30	L	22,06
	RGRAMG110L	110 x 125 x 4"	16		30	L	22,83
	RGRAMG110M	110 x 125 x 5"	16		30	L	31,64

Adaptor Male Threaded / Embout mâle / Übergangsmuffennippel AG / Adattatore con filetto maschio / Adaptador rosca macho

	Code / Codice	d x R (UNI EN 10226)	PN / PFA	Q.tà min / Min. q.ty	Box	Pack / Imballo	€
ADG 	RGRADG090I	90 x 3"	16		45	L	14,02
	RGRADG110L	110 x 4"	16		30	L	19,88
	RGRADG1600	160 x 6"	16		6	L	65,18

Adaptor bush / Réduction d'adaptation / Übergangsreduktion / Riduzione di passaggio / Reducción Mixta

	Code / Codice	d x Rp (UNI EN 10226)	PN / PFA	Q.tà min / Min. q.ty	Box	Pack / Imballo	€
RCG 	RGRRCG025B	25 x 1/2"	16	10	700	S	1,92
	RGRRCG032B	32 x 1/2"	16	10	450	S	1,92
	RGRRCG032C	32 x 3/4"	16	10	450	S	1,88
	RGRRCG040D	40 x 1"	16		250	S	2,66
	RGRRCG050E	50 x 1 1/4"	16		350	M	3,30
	RGRRCG050F	50 x 1 1/2"	16		350	M	7,43
	RGRRCG063F	63 x 1 1/2"	16		180	M	4,36
	RGRRCG063G	63 x 2"	16		180	M	7,65
	RGRRCG075G	75 x 2"	16		110	M	10,09
	RGRRCG090H	90 x 2 1/2"	16		65	M	14,02
	RGRRCG110I	110 x 3"	16		40	M	21,81

Union Brass/nut PVC-u / Union 3 pié laiton/écrou PVC-u / Verschraubung Messing/Überwurfmutter PVC-u
Bocchettone Ottone/ghiera in PVC-u / Unión latón/tuerca PVC-u

	Code / Codice	d x R (UNI EN 10226)	PN / PFA	Q.tà min / Min. q.ty	Box	Pack / Imballo	€
BNG Male 	RGRBNG020B	20 x 1/2"		10	50	S	11,40
	RGRBNG025C	25 x 3/4"		10	30	S	14,59
	RGRBNG032D	32 x 1"		10	30	S	19,10
	RGRBNG040E	40 x 1 1/4"			20	S	29,99
	RGRBNG050F	50 x 1 1/2"			20	S	36,42
	RGRBNG063G	63 x 2"			12	S	55,83
	RGRBNG075H	75 x 2 1/2"			6	S	122,86
	RGRBNG090I	90 x 3"			4	S	139,18

Union Brass/nut PVC-u / Union 3 pié laiton/écrou PVC-u / Verschraubung Messing/Überwurfmutter PVC-u
Bocchettone Ottone/ghiera in PVC-u / Unión latón/tuerca PVC-u

	Code / Codice	d x Rp (UNI EN 10226)	PN / PFA	Q.tà min / Min. q.ty	Box	Pack / Imballo	€
BBG Female 	RGRBBG020B	20 x 1/2"		10	50	S	10,68
	RGRBBG025C	25 x 3/4"		10	30	S	14,14
	RGRBBG032D	32 x 1"		10	30	S	18,21
	RGRBBG040E	40 x 1 1/4"			20	S	28,69
	RGRBBG050F	50 x 1 1/2"			20	S	33,98
	RGRBBG063G	63 x 2"			12	S	53,31
	RGRBBG075H	75 x 2 1/2"			6	S	104,97
	RGRBBG090I	90 x 3"			4	S	116,48

Union Brass/nut PVC-u / Union 3 pié laiton/écrou PVC-u / Verschraubung Messing/Überwurfmutter PVC-u
Bocchettone Ottone/ghiera in PVC-u / Unión latón/tuerca PVC-u

	Code / Codice	d x Rp (UNI EN 10226)	PN / PFA	Q.tà min / Min. q.ty	Box	Pack / Imballo	€
BND Male 	RGRBND020B.N	20 x 1/2"		10	50	S	8,91
	RGRBND025C.N	25 x 3/4"		10	30	S	10,37
	RGRBND032D.N	32 x 1"		10	30	S	13,89
	RGRBND040E.N	40 x 1 1/4"			20	S	18,20
	RGRBND050F.N	50 x 1 1/2"			20	S	24,56
	RGRBND063G.N	63 x 2"			12	S	39,41

Union Brass/nut PVC-u / Union 3 pié laiton/écrou PVC-u / Verschraubung Messing/Überwurfmutter PVC-u
Bocchettone Ottone/ghiera in PVC-u / Unión latón/tuerca PVC-u

	Code / Codice	d x Rp (UNI EN 10226)	PN / PFA	Q.tà min / Min. q.ty	Box	Pack / Imballo	€
BBD Female 	RGRBBD020B.N	20 x 1/2"		10	50	S	8,57
	RGRBBD025C.N	25 x 3/4"		10	30	S	9,36
	RGRBBD032D.N	32 x 1"		10	30	S	13,36
	RGRBBD040E.N	40 x 1 1/4"			20	S	20,24
	RGRBBD050F.N	50 x 1 1/2"			20	S	21,16
	RGRBBD063G.N	63 x 2"			12	S	29,41

90° Elbow reinforced s/s / Coude 90° renforcé inox / Metallringverstärkter Winkel 90° / Gomito a 90° rinforzato inox / Codo 90° mixto con anillo de refuerzo

GOR

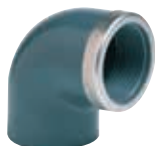

Code / Codice	d x Rp (UNI EN 10226)	PN / PFA	Q.tà min / Min. q.ty	Box	Pack / Imballo	€
RRGOR020B	20 x 1/2"	16	10	250	S	3,83
RRGOR025C	25 x 3/4"	16	10	300	M	5,35
RRGOR032D	32 x 1"	16	10	180	M	5,92
RRGOR040E	40 x 1 1/4"	16		120	M	7,39
RRGOR050F	50 x 1 1/2"	16		120	L	9,95
RRGOR063G	63 x 2"	16		60	L	12,32

Tee thread. reinforced s/s / Té renforcé inox / Metallringverstärktes T-Stück 90° / Ti a 90° bocca rinforzato inox / Te mixta 90° con anillo de refuerzo

TIR



Code / Codice	d x Rp (UNI EN 10226)	PN / PFA	Q.tà min / Min. q.ty	Box	Pack / Imballo	€
RRTIR020B	20 x 1/2"	16	10	400	M	4,84
RRTIR025C	25 x 3/4"	16	10	200	M	5,92
RRTIR032D	32 x 1"	16	10	100	M	6,58
RRTIR040E	40 x 1 1/4"	16		70	M	7,95
RRTIR050F	50 x 1 1/2"	16		80	L	11,55
RRTIR063G	63 x 2"	16		50	L	14,11

Socket Reinforced s/s / Manchon Renforcé inox / Metallringverstärkte Muffe / Manicotto Rinforzato Inox / Manguito con anillo de refuerzo

MAR



Code / Codice	d x Rp (UNI EN 10226)	PN / PFA	Q.tà min / Min. q.ty	Box	Pack / Imballo	€
RGRMAR020B	20 x 1/2"	16	10	350	S	3,40
RGRMAR025C	25 x 3/4"	16	10	450	M	3,80
RGRMAR032D	32 x 1"	16	10	250	M	3,76
RGRMAR040E	40 x 1 1/4"	16		180	M	4,91
RGRMAR050F	50 x 1 1/2"	16		120	M	6,38
RGRMAR063G	63 x 2"	16		75	M	7,83

Adaptor fem. threaded with reinforced s/s / Embout femelle renforcé inox / Verstärkter Reduktionsnippel IG
Adattatore con filetto femm. rinforzato inox / Adaptador con Anillo de Reforzado Rosca Hembra

AFR



1° size: male solvent cement
2° size: female threaded

1° misura: incollaggio maschio
2° misura: filettato femmina

Code / Codice	d x Rp (UNI EN 10226)	PN / PFA	Q.tà min / Min. q.ty	Box	Pack / Imballo	€
RGRAFR020B	20 x 1/2"	16	10	350	S	2,84
RGRAFR020C	20 x 3/4"	16	10	300	S	3,21
RGRAFR025B	25 x 1/2"	16	10	500	M	3,21
RGRAFR025C	25 x 3/4"	16	10	450	M	3,61
RGRAFR025D	25 x 1"	16	10	400	M	3,71
RGRAFR032C	32 x 3/4"	16	10	250	M	3,71
RGRAFR032D	32 x 1"	16	10	250	M	4,24
RGRAFR040D	40 x 1"	16		200	M	4,24
RGRAFR040E	40 x 1 1/4"	16		180	M	4,67
RGRAFR050E	50 x 1 1/4"	16		140	M	4,95
RGRAFR050F	50 x 1 1/2"	16		130	M	6,48
RGRAFR063G	63 x 2"	16		70	M	8,42

BSP Parallel Threaded Fittings / Raccords Filetés Gewindefittings / Serie Filettata / Serie Roscada

Elbow 90° / Coude 90° / Winkel 90° / Gomito a 90° / Codo 90°

	Code / Codice	Rp (UNI EN 10226)	PN / PFA	Q.tà min / Min. q.ty	Box	Pack / Imballo	€
GOE 	REGOE016A	3/8"	16	10	350	S	1,47
	REGOE020B	1/2"	16	10	250	S	1,47
	REGOE025C	3/4"	16	10	300	M	1,86
	REGOE032D	1"	16	10	180	M	2,29
	REGOE040E	1 1/4"	16		120	M	3,30
	REGOE050F	1 1/2"	16		120	L	4,85
	REGOE063G	2"	16		60	L	6,92
	REGOE075H	2 1/2"	16		40	L	17,90
	REGOE090I	3"	16		25	L	24,61
	REGOE110L	4"	16		14	L	40,18

Elbow 45° / Coude 45° / Winkel 45° / Gomito a 45° / Codo 45°

	Code / Codice	Rp (UNI EN 10226)	PN / PFA	Q.tà min / Min. q.ty	Box	Pack / Imballo	€
GYE 	REGYE020B	1/2"	16	10	300	S	2,49
	REGYE025C	3/4"	16	10	400	M	2,62
	REGYE032D	1"	16	10	200	M	3,40
	REGYE040E	1 1/4"	16		150	M	4,68
	REGYE050F	1 1/2"	16		150	L	6,93
	REGYE063G	2"	16		90	L	9,79
	REGYE075H	2 1/2"	16		50	L	22,06
	REGYE090I	3"	16		30	L	28,17
	REGYE110L	4"	16		16	L	49,67

Tee 90° / Tè 90° / T-Stück 90° / Ti a 90° / Te 90°

	Code / Codice	Rp (UNI EN 10226)	PN / PFA	Q.tà min / Min. q.ty	Box	Pack / Imballo	€
TIE 	RERTIE016A	3/8"	16	10	300	S	2,72
	RERTIE020B	1/2"	16	10	400	M	3,11
	RERTIE025C	3/4"	16	10	200	M	3,35
	RERTIE032D	1"	16	10	100	M	3,99
	RERTIE040E	1 1/4"	16		70	M	5,73
	RERTIE050F	1 1/2"	16		90	L	7,20
	RERTIE063G	2"	16		50	L	10,51
	RERTIE075H	2 1/2"	16		32	L	27,32
	RERTIE090I	3"	16		20	L	32,50
	RERTIE110L	4"	16		10	L	49,38

Socket / Manchon / Muffe / Manicotto / Manguito

	Code / Codice	Rp (UNI EN 10226)	PN / PFA	Q.tà min / Min. q.ty	Box	Pack / Imballo	€
MAE 	RERMAE016A	3/8"	16	10	450	S	1,54
	RERMAE020B	1/2"	16	10	350	S	1,78
	RERMAE025C	3/4"	16	10	450	M	1,95
	RERMAE032D	1"	16	10	250	M	2,34
	RERMAE040E	1 1/4"	16		190	M	3,07
	RERMAE050F	1 1/2"	16		140	M	3,99
	RERMAE063G	2"	16		85	M	5,23
	RERMAE075H	2 1/2"	16		45	M	15,37
	RERMAE090I	3"	16		60	M	18,35
	RERMAE110L	4"	16		30	L	26,50

Plug / Bouchon / Stopfen / Tappo / Tapón

	Code / Codice	R (UNI EN 10226)	PN / PFA	Q.tà min / Min. q.ty	Box	Pack / Imballo	€
TAE 	RERTAE016A	3/8"	16	10	1200	S	0,89
	RERTAE020B	1/2"	16	10	650	S	0,89
	RERTAE025C	3/4"	16	10	400	S	1,20
	RERTAE032D	1"	16	10	500	M	1,45
	RERTAE040E	1 1/4"	16		350	M	2,05
	RERTAE050F	1 1/2"	16		280	M	2,33
	RERTAE063G	2"	16		160	M	3,20
	RERTAE075H	2 1/2"	16		80	M	10,34
	RERTAE090I	3"	16		50	M	13,24
	RERTAE110L	4"	16		36	M	22,06

Cap / Bouchon / Kappe / Calotta / Tapón

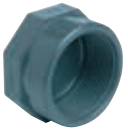
	Code / Codice	Rp (UNI EN 10226)	PN / PFA	Q.tà min / Min. q.ty	Box	Pack / Imballo	€
CAE 	RERCAE016A	3/8"	16	10	1000	S	1,32
	RERCAE020B	1/2"	16	10	500	S	1,37
	RERCAE025C	3/4"	16	10	300	S	1,53
	RERCAE032D	1"	16	10	180	S	1,66
	RERCAE040E	1 1/4"	16		120	S	2,51
	RERCAE050F	1 1/2"	16		230	M	2,93
	RERCAE063G	2"	16		120	M	3,99
	RERCAE075H	2 1/2"	16		60	M	13,73
	RERCAE090I	3"	16		30	M	17,81
	RERCAE110L	4"	16		25	M	22,91

Reducing Bush / Réduction courte / Reduktion kurz / Riduzione M./F. corta / Reducción corta

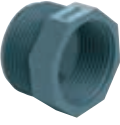
	Code / Codice	R x Rp (UNI EN 10226)	PN / PFA	Q.tà min / Min. q.ty	Box	Pack / Imballo	€
RCE 	RERRCE020A	1/2" x 3/8"	16	10	450	S	1,30
	RERRCE025B	3/4" x 1/2"	16	10	380	S	1,30
	RERRCE032C	1" x 3/4"	16	10	500	M	1,62
	RERRCE040D	1 1/4" x 1"	16		300	M	2,51
	RERRCE050E	1 1/2" x 1 1/4"	16		270	M	3,27
	RERRCE063F	2" x 1 1/2"	16		160	M	4,32
	RERRCE075G	2 1/2" x 2"	16		90	M	9,59
	RERRCE090H	3" x 2 1/2"	16		50	M	13,66
	RERRCE110I	4" x 3"	16		50	L	21,75

Reducing Socket / Manchon réduit / Reduziermuffe / Manicotto ridotto / Manguito Reducido

	Code / Codice	Rp (UNI EN 10226)	PN / PFA	Q.tà min / Min. q.ty	Box	Pack / Imballo	€
MRE 	RERMRE020A	1/2" x 3/8"	16	10	450	S	2,61
	RERMRE025B	3/4" x 1/2"	16	10	450	M	2,61
	RERMRE032C	1" x 3/4"	16	10	300	M	2,83
	RERMRE040D	1 1/4" x 1"	16		200	M	3,47
	RERMRE050E	1 1/2" x 1 1/4"	16		160	M	5,10
	RERMRE063F	2" x 1 1/2"	16		100	M	7,04
	RERMRE075G	2 1/2" x 2"	16		50	M	15,44
	RERMRE090H	3" x 2 1/2"	16		50	L	18,44
	RERMRE110I	4" x 3"	16		35	L	26,50

Reducer / Réduction / Reduziermutternippel / Maggioratore / Reducción

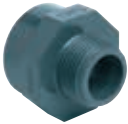
	Code / Codice	Rp x R (UNI EN 10226)	PN / PFA	Q.tà min / Min. q.ty	Box	Pack / Imballo	€
MGE 	RERMGE016B	3/8" x 1/2"	16	10	500	S	2,30
	RERMGE020C	1/2" x 3/4"	16	10	250	S	2,43
	RERMGE025D	3/4" x 1"	16	10	150	S	2,58
	RERMGE032E	1" x 1 1/4"	16	10	220	M	2,81
	RERMGE040F	1 1/4" x 1 1/2"	16		150	M	3,25
	RERMGE050G	1 1/2" x 2"	16		140	M	4,22
	RERMGE063H	2" x 2 1/2"	16		72	M	8,55
	RERMGE075I	2 1/2" x 3"	16		50	M	11,46
	RERMGE090L	3" x 4"	16		25	M	19,31

Nipple Reduced / Mamelon réduit / Reduziernippel / Nipplo ridotto / Machón reducido

	Code / Codice	R x R (UNI EN 10226)	PN / PFA	Q.tà min / Min. q.ty	Box	Pack / Imballo	€
NRE 	RERNRE020A	1/2" x 3/8"	16	10	650	S	1,74
	RERNRE025B	3/4" x 1/2"	16	10	350	S	1,93
	RERNRE032C	1" x 3/4"	16	10	450	M	2,33
	RERNRE040D	1 1/4" x 1"	16		270	M	3,11
	RERNRE050E	1 1/2" x 1 1/4"	16		180	M	3,96
	RERNRE063F	2" x 1 1/2"	16		110	M	5,61
	RERNRE075G	2 1/2" x 2"	16		80	M	10,26
	RERNRE090G	3" x 2"	16		40	M	13,24
	RERNRE090H	3" x 2 1/2"	16		35	M	13,24
	RERNRE110I	4" x 3"	16		24	M	20,29

Nipple / Mamelon / Doppelnippel / Nipplo / Machón

Code / Codice	R (UNI EN 10226)	PN / PFA	Q.tà min / Min. q.ty	Box	Pack / Imballo	€
RERNIE016A	3/8"			1000	S	1,08
RERNIE020B	1/2"			450	S	1,16
RERNIE025C	3/4"			600	M	1,37
RERNIE032D	1"			350	M	1,66
RERNIE040E	1 1/4"			220	M	2,17
RERNIE050F	1 1/2"			200	M	2,56
RERNIE063G	2"			200	L	3,40
RERNIE075H	2 1/2"			110	L	9,33
RERNIE090I	3"			70	L	12,81
RERNIE110L	4"			35	L	20,29



Reducer / Réduction / Reduzierstück / Riduzione / Reducción

Code / Codice	R x Rp (UNI EN 10226)	PN / PFA	Q.tà min / Min. q.ty	Box	Pack / Imballo	€
RERRIE020A	1/2" x 3/8"		10	500	S	1,39
RERRIE025A	3/4" x 3/8"		10	400	S	1,39
RERRIE025B	3/4" x 1/2"		10	280	S	1,39
RERRIE032A	1" x 3/8"		10	500	M	1,65
RERRIE032B	1" x 1/2"		10	500	M	1,65
RERRIE032C	1" x 3/4"		10	450	M	1,65
RERRIE040B	1 1/4" x 1/2"			300	M	2,40
RERRIE040C	1 1/4" x 3/4"			280	M	2,40
RERRIE040D	1 1/4" x 1"			260	M	2,40
RERRIE050C	1 1/2" x 3/4"			220	M	3,11
RERRIE050D	1 1/2" x 1"			220	M	3,11
RERRIE050E	1 1/2" x 1 1/4"			180	M	3,11
RERRIE063D	2" x 1"			130	M	4,24
RERRIE063E	2" x 1 1/4"			120	M	4,24
RERRIE063F	2" x 1 1/2"			120	M	4,24
RERRIE075E	2 1/2" x 1 1/4"			60	M	9,49
RERRIE075F	2 1/2" x 1 1/2"			60	M	9,49
RERRIE075G	2 1/2" x 2"			60	M	9,49
RERRIE090F	3" x 1 1/2"			40	M	12,48
RERRIE090G	3" x 2"			30	M	12,48
RERRIE090H	3" x 2 1/2"			40	L	12,48
RERRIE110G	4" x 2"			40	L	20,36
RERRIE110H	4" x 2 1/2"			40	L	20,36
RERRIE110I	4" x 3"			40	L	20,36



Solvent Cement Fittings BS / Raccordi à Coller BS / Klebefittings BS Raccordi Incollaggio BS / Accesorios Para Encolar BS

Elbow 90° Plain / Coude 90° / Winkel 90° / Gomito 90° / Codo 90°

	Code / Codice	d	PN / PFA	Q.tà min / Min. q.ty	Box	Pack / Imballo	€
GOA 	RARGOA0160	3/8"	15	10	350	S	0,89
	RARGOA0200	1/2"	15	10	250	S	1,06
	RARGOA0250	3/4"	15	10	300	M	1,16
	RARGOA0320	1"	15	10	180	M	1,37
	RARGOA0400	1 1/4"	15		120	M	2,51
	RARGOA0500	1 1/2"	15		120	L	3,42
	RARGOA0630	2"	15		60	L	4,80
	RARGOA0750	2 1/2"	15		40	L	11,12
	RARGOA0900	3"	15		25	L	15,13
	RARGOA1100	4"	15		13	L	21,66
	RARGOA1400	5"	15		6	L	52,81
	RARGOA1600	6"	15		4	L	80,42
	RARGOA2250	8"	9		1	L	207,91

Elbow 45° / Coude 45° / Winkel 45° / Gomito 45° / Codo 45°

	Code / Codice	d	PN / PFA	Q.tà min / Min. q.ty	Box	Pack / Imballo	€
GYA 	RARGYA0160	3/8"	15	10	500	S	1,53
	RARGYA0200	1/2"	15	10	300	S	1,62
	RARGYA0250	3/4"	15	10	400	M	1,77
	RARGYA0320	1"	15	10	200	M	2,38
	RARGYA0400	1 1/4"	15		150	M	3,07
	RARGYA0500	1 1/2"	15		150	L	4,02
	RARGYA0630	2"	15		90	L	5,53
	RARGYA0750	2 1/2"	15		50	L	10,03
	RARGYA0900	3"	15		30	L	13,66
	RARGYA1100	4"	15		16	L	29,42
	RARGYA1400	5"	15		6	L	52,89
	RARGYA1600	6"	15		4	L	62,44
	RARGYA2250	8"	9		2	L	154,78

Bend 90° / Courbe 90° / Bogen 90° / Curva 90° / Curva 90°

	Code / Codice	d	PN / PFA	Q.tà min / Min. q.ty	Box	Pack / Imballo	€
CUA 	RARCUA0200	1/2"	15	10	300	M	5,33
	RARCUA0250	3/4"	15	10	150	M	6,41
	RARCUA0320	1"	15	10	100	M	7,33
	RARCUA0400	1 1/4"	15		50	M	10,58
	RARCUA0500	1 1/2"	15		60	L	13,91
	RARCUA0630	2"	15		30	L	18,45
	RARCUA0750	2 1/2"	15		15	L	40,45
	RARCUA0900	3"	15		9	L	50,55
	RARCUA1100	4"	15		6	L	81,46

Socket Plain / Manchon / Muffe / Manicotto / Manguito

	Code / Codice	d	PN / PFA	Q.tà min / Min. q.ty	Box	Pack / Imballo	€
MAA 	RARMAA0160	3/8"	15	10	500	S	0,79
	RARMAA0200	1/2"	15	10	350	S	0,84
	RARMAA0250	3/4"	15	10	400	M	0,90
	RARMAA0320	1"	15	10	250	M	0,97
	RARMAA0400	1 1/4"	15		180	M	1,55
	RARMAA0500	1 1/2"	15		200	L	1,89
	RARMAA0630	2"	15		100	L	2,77
	RARMAA0750	2 1/2"	15		80	L	6,22
	RARMAA0900	3"	15		45	L	10,50
	RARMAA1100	4"	15		24	L	14,96
	RARMAA1400	5"	15		12	L	30,37
	RARMAA1600	6"	15		6	L	36,57
	RARMAA2250	8"	9		2	L	113,57

Tee 90° Plain / Te' 90° / T-Stück 90° / Ti 90° / Te 90°

TIA



Code / Codice	d	PN / PFA	Q.tà min / Min. q.ty	Box	Pack / Imballo	€
RARTIA0160	3/8"	15	10	300	S	1,18
RARTIA0200	1/2"	15	10	400	M	1,22
RARTIA0250	3/4"	15	10	200	M	1,45
RARTIA0320	1"	15	5	100	M	1,80
RARTIA0400	1 1/4"	15		70	M	2,94
RARTIA0500	1 1/2"	15		80	L	4,16
RARTIA0630	2"	15		50	L	6,36
RARTIA0750	2 1/2"	15		32	L	12,53
RARTIA0900	3"	15		20	L	17,52
RARTIA1100	4"	15		9	L	29,61
RARTIA1400	5"	15		4	L	78,00
RARTIA1600	6"	15		3	L	95,14
RARTIA2250	8"	9		1	L	231,90

Cap Plain / Bouchon / Kappe / Calotta / Tapón

CAA

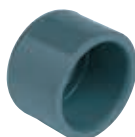

Code / Codice	d	PN / PFA	Q.tà min / Min. q.ty	Box	Pack / Imballo	€
RARCAA0160	3/8"	15	10	500	S	0,73
RARCAA0200	1/2"	15	10	500	S	0,80
RARCAA0250	3/4"	15	10	350	S	0,97
RARCAA0320	1"	15	10	400	M	1,10
RARCAA0400	1 1/4"	15		250	M	1,56
RARCAA0500	1 1/2"	15		180	M	2,16
RARCAA0630	2"	15		100	M	2,91
RARCAA0750	2 1/2"	15		60	M	6,94
RARCAA0900	3"	15		65	L	9,67
RARCAA1100	4"	15		40	L	13,66
RARCAA1400	5"	15		20	L	25,39
RARCAA1600	6"	15		10	L	35,22
RARCAA2250	8"	9		6	L	130,99

Reducing Bush Plain / Réduction Courte / Reduktion kurz / Riduzione Corta / Reducción corta

RCA



Code / Codice	d	PN / PFA	Q.tà min / Min. q.ty	Box	Pack / Imballo	€
RARRCA020A	1/2" x 3/8"	15	10	1000	S	0,80
RARRCA025B	3/4" x 1/2"	15	10	700	S	0,80
RARRCA032B	1" x 1/2"	15	10	450	S	1,08
RARRCA032C	1" x 3/4"	15	10	450	S	1,08
RARRCA040D	1 1/4" x 1"	15		300	S	1,23
RARRCA050C	1 1/2" x 3/4"	15		350	M	1,38
RARRCA050D	1 1/2" x 1"	15		350	M	1,38
RARRCA050E	1 1/2" x 1 1/4"	15		350	M	1,38
RARRCA063D	2" x 1"	15		180	M	2,35
RARRCA063E	2" x 1 1/4"	15		180	M	2,35
RARRCA063F	2" x 1 1/2"	15		180	M	2,35
RARRCA075F	2 1/2" x 1 1/2"	15		110	M	3,34
RARRCA075G	2 1/2" x 2"	15		110	M	3,34
RARRCA090F	3" x 1 1/2"	15		65	M	6,42
RARRCA090G	3" x 2"	15		65	M	6,42
RARRCA090H	3" x 2 1/2"	15		65	M	6,42
RARRCA110G	4" x 2"	15		35	M	8,28
RARRCA110I	4" x 3"	15		35	M	8,28
RARRCA140L	5" x 4"	15		40	L	23,67
RARRCA160L	6" x 4"	15		21	L	26,95
RARRCA2250	8" x 6"	9		7	L	72,28

Stub Flange (Serrated Face) / Collet Strié / Bundbuchse gerillt / Collare Per Flange Rigato / Manguito portabridas

	Code / Codice	d	PN / PFA	Q.tà min / Min. q.ty	Box	Pack / Imballo	€
QRA 	RARQRA0200	1/2"	15	10	500	S	1,02
	RARQRA0250	3/4"	15	10	300	S	1,15
	RARQRA0320	1"	15	10	200	S	1,20
	RARQRA0400	1 1/4"	15		200	M	1,77
	RARQRA0500	1 1/2"	15		180	M	2,72
	RARQRA0630	2"	15		90	M	4,40
	RARQRA0750	2 1/2"	15		120	L	6,94
	RARQRA0900	3"	15		70	L	8,49
	RARQRA1100	4"	15		40	L	11,12
	RARQRA1400	5"	15		20	L	26,12
	RARQRA1600	6"	15		12	L	29,13
	RARQRA2250	8"	9		4	L	69,11

Fixed Flange Drilled to BS / Bride Collet Percement BS 10 / Flansch Bohrung BS 10 / Flangia Fissa Foratura BS 10 / Brida fija perforada BS 10

	Code / Codice	d	PN / PFA	Q.tà min / Min. q.ty	Box	Pack / Imballo	€
FFA 	RARFFA0200	1/2"	15	10	100	S	4,45
	RARFFA0250	3/4"	15	10	60	S	4,77
	RARFFA0320	1"	15	10	50	S	6,21
	RARFFA0400	1 1/4"	15		50	M	6,21
	RARFFA0500	1 1/2"	15		48	M	10,65
	RARFFA0630	2"	15		36	M	12,30
	RARFFA0750	2 1/2"	15		15	M	14,80
	RARFFA0900	3"	15		10	M	17,60
	RARFFA1100	4"	15		20	L	22,72

Full Face Flange Drilled to BS 4504 / Bride Collet Percement BS 4504 / Flansch Bohrung BS 4504 / Flangia Fissa Foratura BS 4504 / Brida fija perforada BS 4504

	Code / Codice	d	PN / PFA	Q.tà min / Min. q.ty	Box	Pack / Imballo	€
FNA 	RARFNA0200	1/2"	15	10	100	S	4,34
	RARFNA0250	3/4"	15	10	60	S	4,69
	RARFNA0320	1"	15	10	50	S	6,12
	RARFNA0400	1 1/4"	15		50	M	7,83
	RARFNA0500	1 1/2"	15		48	M	9,43
	RARFNA0630	2"	15		36	M	12,17
	RARFNA0750	2 1/2"	15		15	M	14,66
	RARFNA0900	3"	15		10	M	17,60
	RARFNA1100	4"	15		20	L	22,72

Adaptor Fittings BS / Raccords d'Adaptation BS / Übergangsfittings BS Raccordi di Passaggio BS / Accesorios Mixto Encolar BS

Elbow 90° / Coude 90° / Winkel 90° / Gomito 90° / Codo 90°

GOC



Code / Codice	d x Rp (UNI EN 10226)	PN / PFA	Q.tà min / Min. q.ty	Box	Pack / Imballo	€
RCRGOC020B	1/2" x 1/2"	15	10	250	S	1,69
RCRGOC025C	3/4" x 3/4"	15	10	300	M	1,97
RCRGOC032D	1" x 1"	15	10	180	M	2,29
RCRGOC040E	1 1/4" x 1 1/4"	15		120	M	4,52
RCRGOC050F	1 1/2" x 1 1/2"	15		120	L	6,27
RCRGOC063G	2" x 2"	15		60	L	8,57
RCRGOC075H	2 1/2" x 2 1/2"	15		40	L	17,84
RCRGOC090I	3" x 3"	15		25	L	26,02
RCRGOC110L	4" x 4"	15		14	L	41,26

Socket / Manchon / Muffe / Manicotto / Manguito

MAB



Code / Codice	d x d	PN / PFA	Q.tà min / Min. q.ty	Box	Pack / Imballo	€
RBRMAB020B	1/2" x 20	15	10	350	S	1,23
RBRMAB025C	3/4" x 25	15	10	450	M	1,40
RBRMAB032D	1" x 32	15	10	250	M	1,95
RBRMAB040E	1 1/4" x 40	15		180	M	3,18
RBRMAB050F	1 1/2" x 50	15		200	L	4,60
RBRMAB063G	2" x 63	15		100	L	6,95
RBRMAB090I	3" x 90	15		45	L	18,67
RBRMAB110L	4" x 110	15		24	L	29,31
RBRMAB160O	6" x 160	15		6	L	53,32

Tee 90° / Tè 90° / T-Stück 90° / Ti 90° / Te 90°

TIC



Code / Codice	d x Rp (UNI EN 10226)	PN / PFA	Q.tà min / Min. q.ty	Box	Pack / Imballo	€
RCRTIC020B	1/2" x 1/2"	15	10	400	M	1,86
RCRTIC025C	3/4" x 3/4"	15	10	200	M	2,23
RCRTIC032D	1" x 1"	15	10	100	M	2,95
RCRTIC040E	1 1/4" x 1 1/4"	15		70	M	4,16
RCRTIC050F	1 1/2" x 1 1/2"	15		80	L	6,21
RCRTIC063G	2" x 2"	15		50	L	10,34
RCRTIC075H	2 1/2" x 2 1/2"	15		32	L	19,03
RCRTIC090I	3" x 3"	15		20	L	28,92
RCRTIC110L	4" x 4"	15		10	L	46,20

Adaptor / Embout / Übergangsmuffe / Adattatore / Adaptor

MAC



Code / Codice	d x Rp (UNI EN 10226)	PN / PFA	Q.tà min / Min. q.ty	Box	Pack / Imballo	€
RCRMAC020B	1/2" x 1/2"	15	10	350	S	1,59
RCRMAC025C	3/4" x 3/4"	15	10	450	M	1,67
RCRMAC032D	1" x 1"	15	10	250	M	1,89
RCRMAC040E	1 1/4" x 1 1/4"	15		180	M	2,74
RCRMAC050F	1 1/2" x 1 1/2"	15		120	M	4,16
RCRMAC063G	2" x 2"	15		75	M	5,70
RCRMAC075H	2 1/2" x 2 1/2"	15		36	M	16,66
RCRMAC090I	3" x 3"	15		45	L	18,11
RCRMAC110L	4" x 4"	15		30	L	26,50

Adaptor Female / Embout Femelle / Übergangsnippel IG / Adattatore F / Adaptador hembra

AFC



1° size: male solvent cement
2° size: female threaded
1° misura: incollaggio maschio
2° misura: filettato femmina

Code / Codice	d x Rp (UNI EN 10226)	PN / PFA	Q.tà min / Min. q.ty	Box	Pack / Imballo	€
RCRAFC020B	1/2" x 1/2"	15	10	350	S	2,17
RCRAFC025C	3/4" x 3/4"	15	10	450	M	2,51
RCRAFC032C	1" x 3/4"	15	10	250	M	3,06
RCRAFC040E	1 1/4" x 1 1/4"	15		180	M	3,27
RCRAFC050F	1 1/2" x 1 1/2"	15		110	M	4,07
RCRAFC063G	2" x 2"	15		70	M	6,86
RCRAFC075H	2 1/2" x 2 1/2"	15		80	L	12,60

Adaptor Male / Embout Mâle / Übergangsnippel AG / Adattatore M / Adaptador macho

AMC



1° size: female solvent cement
2° size: male solvent cement
3° size: male threaded
1° misura: incollaggio femmina
2° misura: incollaggio maschio
3° misura: filettato maschio

Code / Codice	d x d x R (UNI EN 10226)	PN / PFA	Q.tà min / Min. q.ty	Box	Pack / Imballo	€
RCRAMC020B	1/2" x 3/4" x 1/2"	15	10	300	S	1,09
RCRAMC025C	3/4" x 1" x 3/4"	15	10	400	M	1,30
RCRAMC032D	1" x 1 1/4" x 1"	15	10	250	M	1,65
RCRAMC040E	1 1/4" x 1 1/2" x 1 1/4"	15		240	M	2,38
RCRAMC050F	1 1/2" x 2" x 1 1/2"	15		120	M	3,45
RCRAMC063G	2" x 2 1/2" x 2"	15		45	M	4,31
RCRAMC075H	2 1/2" x 3" x 2 1/2"	15		45	M	12,70
RCRAMC090I	3" x 4" x 3"	15		45	L	15,59
RCRAMC110L	4" x 5" x 4"	15		30	L	23,05

Adaptor Fittings BS / Raccords d'Adaptation BS Übergangsfittings BS / Serie di Passaggio BS / Serie de Mixta BS

Union Brass PVC-u BS / Union 3 Pié laiton PVC-u BS / Verschraubung aus Messing PVC-u BS / Bocchettone Ottone in PVC-u BS / Unión latón PVC-u BS

	Code / Codice	d x R (UNI EN 10226)	PN / PFA	Q.tà min / Min. q.ty	Box	Pack / Imballo	€
BNC 	RCRBNC020B	1/2"		10	50	S	11,40
	RCRBNC025C	3/4"		10	30	S	14,59
	RCRBNC032D	1"		10	30	S	19,10
	RCRBNC040E	1 1/4"			20	S	29,99
	RCRBNC050F	1 1/2"			20	S	36,42
	RCRBNC063G	2"			12	S	55,83
	RCRBNC075H	2 1/2"			6	S	122,86
	RCRBNC090I	3"			4	S	139,18

Union Brass PVC-u BS / Union 3 Pié laiton PVC-u BS / Verschraubung aus Messing PVC-u BS / Bocchettone Ottone in PVC-u BS / Unión latón PVC-u BS

	Code / Codice	d x Rp (UNI EN 10226)	PN / PFA	Q.tà min / Min. q.ty	Box	Pack / Imballo	€
BBC 	RCRBBC020B	1/2"		10	50	S	10,68
	RCRBBC025C	3/4"		10	30	S	14,14
	RCRBBC032D	1"		10	30	S	18,21
	RCRBBC040E	1 1/4"			20	S	28,69
	RCRBBC050F	1 1/2"			20	S	33,98
	RCRBBC063G	2"			12	S	53,31
	RCRBBC075H	2 1/2"			6	S	104,97
	RCRBBC090I	3"			4	S	116,48

Union Brass/nut PVC-u / Union 3 pié laiton/écrou PVC-u / Verschraubung Messing/Überwurfmutter PVC-u
Bocchettone Ottone/ghiera in PVC-u / Unión latón/tuerca PVC-u

	Code / Codice	d x Rp (UNI EN 10226)	PN / PFA	Q.tà min / Min. q.ty	Box	Pack / Imballo	€
BND Male 	RCRBND020B.N	1/2"		10	50	S	8,91
	RCRBND025C.N	3/4"		10	30	S	10,37
	RCRBND032D.N	1"		10	30	S	13,89
	RCRBND040E.N	1 1/4"			20	S	18,20
	RCRBND050F.N	1 1/2"			20	S	24,56
	RCRBND063G.N	2"			12	S	39,41

Union Brass/nut PVC-u / Union 3 pié laiton/écrou PVC-u / Verschraubung Messing/Überwurfmutter PVC-u
Bocchettone Ottone/ghiera in PVC-u / Unión latón/tuerca PVC-u

	Code / Codice	d x Rp (UNI EN 10226)	PN / PFA	Q.tà min / Min. q.ty	Box	Pack / Imballo	€
BBD Female 	RCRBBD020B.N	1/2"		10	50	S	8,57
	RCRBBD025C.N	3/4"		10	30	S	9,36
	RCRBBD032D.N	1"		10	30	S	13,36
	RCRBBD040E.N	1 1/4"			20	S	20,24
	RCRBBD050F.N	1 1/2"			20	S	21,16
	RCRBBD063G.N	2"			12	S	29,41

90° Elbow reinforced s/s BS / Coude 90° renforcé inox BS / Metallringverstärkter Winkel 90° BS
Gomito a 90° rinforzato inox BS / Codo 90° mixto con anillo de refuerzo BS

	Code / Codice	d (UNI EN 10226)	PN / PFA	Q.tà min / Min. q.ty	Box	Pack / Imballo	€
GOCR 	RCRGOCR020B	1/2"x1/2"		10	350	S	3,87
	RCRGOCR025C	3/4" x 3/4"		10	350	M	5,40
	RCRGOCR032D	1" x 1"		10	200	M	5,98
	RCRGOCR040E	1 1/4" x 1 1/4"			120	M	7,46
	RCRGOCR050F	1 1/2" x 1 1/2"			140	L	10,05
	RCRGOCR063G	2" x 2"			70	L	12,44

Tee thread. reinforced s/s BS / Té renforcé inox BS / Metallringverstärktes T-Stück 90° BS
Ti a 90° bocca rinforzato inox BS / Te mixta 90° con anillo de refuerzo BS

	Code / Codice	d (UNI EN 10226)	PN / PFA	Q.tà min / Min. q.ty	Box	Pack / Imballo	€
TICR 	RCRTICR020B	1/2" x 1/2"		10	400	M	4,89
	RCRTICR025C	3/4" x 3/4"		10	240	M	5,98
	RCRTICR032D	1" x 1"		10	100	M	6,64
	RCRTICR040E	1 1/4" x 1 1/4"			80	M	8,03
	RCRTICR050F	1 1/2" x 1 1/2"			90	L	11,66
	RCRTICR063G	2" x 2"			50	L	14,24

Adaptor Fittings BS / Raccordi d'Adaptation BS Übergangsfittings BS / Serie di Passaggio BS / Serie de Mixta BS

Socket Reinforced s/s BS / Manchon Renforcé inox BS / Metallringverstärkte Muffe BS / Manicotto rinforzato inox BS / Manguito con anillo de refuerzo BS

MACR



Code / Codice	d (UNI EN 10226)	PN / PFA	Q.tà min / Min. q.ty	Box	Pack / Imballo	€
RCRMACR020B	1/2" x 1/2"		10	350	S	3,43
RCRMACR025C	3/4" x 3/4"		10	450	M	3,84
RCRMACR032D	1" x 1"		10	250	M	3,87
RCRMACR040E	1 1/4" x 1 1/4"			180	M	4,95
RCRMACR050F	1 1/2" x 1 1/2"			120	M	6,45
RCRMACR063G	2" x 2"			75	M	7,91

Adaptor fem. threaded with reinforced s/s BS / Embout femelle renforcé inox BS / Verstärkter Reduktionsnippel BS
Adattatore con filetto femm. rinforzato inox BS / Adaptador con anillo de refuerzo rosca hembra BS

AFCR



Code / Codice	d (UNI EN 10226)	PN / PFA	Q.tà min / Min. q.ty	Box	Pack / Imballo	€
RCRAFCR020B	1/2" x 1/2"		10	350	S	2,87
RCRAFCR025C	3/4" x 3/4"		10	450	M	3,24
RCRAFCR032D	1" x 1"		10	250	M	3,24
RCRAFCR040E	1 1/4" x 1 1/4"			180	M	3,64
RCRAFCR050F	1 1/2" x 1 1/2"			140	M	3,74
RCRAFCR063G	2" x 2"			70	M	4,28

Accessories / Accessoires / Zubehör Accessori / Accesorios

Hose adaptor MM / Douille MM / Druckschlauchtülle MM / Portagomma MM / Adaptador manguera MM

PGD



Code / Codice	d x D	PN / PFA	Q.tà min / Min. q.ty	Box	Pack / Imballo	€
RDRPGD0120	12 x 12		10	700	S	1,07
RDRPGD0160	16 x 16		10	450	S	1,34
RDRPGD0200	20 x 20		10	300	S	1,49
RDRPGD0250	25 x 25		10	150	S	1,59
RDRPGD0320	32 x 30		10	250	M	1,69
RDRPGD0400	40 x 40			280	L	2,26
RDRPGD0500	50 x 50			80	M	3,87
RDRPGD0630	63 x 60			50	M	6,10

Hose Adaptor Threaded / Douille fileté / Gewinde Druckschlauchtülle / Portagomma filettato / Conexión manguera rosca

PGE



Code / Codice	D x R (UNI EN 10226)	PN / PFA	Q.tà min / Min. q.ty	Box	Pack / Imballo	€
RERPGE016A	16 x 3/8"		10	500	S	1,37
RERPGE020B	20 x 1/2"		10	300	S	1,41
RERPGE025C	25 x 3/4"		10	180	S	1,59
RERPGE032D	32 x 1"		10	250	M	1,69
RERPGE040E	40 x 1 1/4"			300	L	3,02
RERPGE050F	50 x 1 1/2"			100	M	3,72
RERPG E063G	63 x 2"			50	M	6,74

Barrel Nipple Long / Manchon double long / Gewindestange / Barra forata filettata / Barra rosca

BNE



Code / Codice	R (UNI EN 10226)	Lenght Lunghezza	Q.tà min / Min. q.ty	Box	Pack / Imballo	€
RERBNE020B	1/2"	60		320	S	2,95
RERBNE025C	3/4"	60		240	M	3,20
RERBNE032D	1"	80		260	M	3,35
RERBNE040E	1 1/4"	80		160	M	4,39
RERBNE050F	1 1/2"	80		100	M	4,84
RERBNE063G	2"	100		60	M	6,31
RERBNE075H	2 1/2"	120		50	M	9,05
RERBNE090I	3"	150		60	L	12,85
RERBNE110L	4"	150		30	L	17,58

Backnut / Ecrou / Überwurfmutter / Ghiera / Tuerca

	Code / Codice	Rp (UNI EN 10226)	PN / PFA	Q.tà min / Min. q.ty	Box	Pack / Imballo	€
NUE 	RERNUE020B	1/2"		10	700	S	1,58
	RERNUE025C	3/4"		10	600	S	1,78
	RERNUE032D	1"		10	500	M	2,42
	RERNUE040E	1 1/4"			450	M	3,54
	RERNUE050F	1 1/2"			300	M	4,11
	RERNUE063G	2"			150	M	5,96
	RERNUE075H	2 1/2"			100	M	6,68
	RERNUE090I	3"			60	M	7,46
	RERNUE110L	4"			40	M	8,96

Tank Adaptor / Passe Paroi / Tankanschluss / Passa Parete / Pasamuros

	Code / Codice	R (UNI EN 10226)	Lenght / Lunghezza	Q.tà min / Min. q.ty	Box	Pack / Imballo	€
ASE 	RERASE020B	1/2"	60		150	S	7,65
	RERASE025C	3/4"	60		100	S	8,40
	RERASE032D	1"	80		60	S	10,34
	RERASE040E	1 1/4"	80		50	M	14,75
	RERASE050F	1 1/2"	80		40	M	17,59
	RERASE063G	2"	100		30	M	22,30
	RERASE075H	2 1/2"	120		15	M	28,35
	RERASE090I	3"	150		10	M	31,87
	RERASE110L	4"	150		10	L	40,82

Container Adaptor / Traversée de Paroi / Behälterverschraubung / Attacco a Serbatoio / Pasamuros

	Code / Codice	d (UNI EN 10226)	PN / PFA	Q.tà min / Min. q.ty	Box	Pack / Imballo	€
ATE 	RERATE050F	1 1/2"		10	125	M	11,41

Container Adaptor BSP / Traversée de Paroi BSP / Behälterverschraubungen BSP / Attacco a Serbatoio BSP / Pasamuros BSP

	Code / Codice	D x d x Rp (UNI EN 10226)	PN / PFA	Q.tà min / Min. q.ty	Box	Pack / Imballo	€
AKE 	RERAKE020C	20 x 25 x 3/4			1		23,20
	RERAKE025D	25 x 32 x 1			1		25,28
	RERAKE032E	32 x 40 x 1 1/4			1		29,33
	RERAKE050G	50 x 63 x 2			1		40,32
	RERAKE063H	63 x 75 x 2 1/2			1		69,33
	RERAKE075I	75 x 90 x 3			1		100,57

U-PVC Tank adaptor with seal / Traversée de paroi en Pvc-u avec joints / Pvc-u Behälter-anschluss mit Dichtung Attacco per serbatoio in PVC-u con guarnizione / Pasamuro en Pvc-u con juntos

	Code / Codice	d x R (UNI EN 10226)	D1	D2	L	CH	PN / PFA	Box	Pack / Imballo	€
ATS 	RERATS063F	2 x 1 1/2"	2"	1 1/2"	59	75	N.A.	40	S	10,64

Pipeclips with top clip / Clip avec bloquage / Rohrhalter mit Bügel / Portatubi con chiusura / Abrazadera cerrada para tubería

	Code / Codice	d	PN / PFA	Q.tà min / Min. q.ty	Box	Pack / Imballo	€
PTD 	RDRPTD0200	20		10	2000	L	0,71
	RDRPTD0250	25		10	2000	L	0,80
	RDRPTD0320	32		10	800	L	0,90
	RDRPTD0400	40		10	500	L	1,07
	RDRPTD0500	50		10	300	L	1,34
	RDRPTD0630	63		10	250	L	1,71
	RDRPTD0750	75			220	L	10,70
	RDRPTD0900	90			200	L	11,08
	RDRPTD1100	110			180	L	12,43
	RDRPTD1250	125			130	L	25,75
	RDRPTD1400	140			110	L	28,80
	RDRPTD1600	160			30	L	29,45

Pipes / Tuyaux / Rohre Tubi / Tubos

PVC Pipes / PVC Tuyaux / PVC Rohre / Tubi in PVC / Tubos en Pvc

	Code / Codice	d	€ - PN 6	€ - PN 10	€ - PN 12,5	€ - PN 16	€ - PN 20	€ - Guar. Gomma
	TDRT0160	16					0,62	
	TDRT0200	20				0,75	0,91	
	TDRT0250	25			0,99	1,16	1,39	
	TDRT0320	32		0,95	1,09	1,34	1,56	
	TDRT0400	40	1,04	1,28	1,60	1,91	2,27	0,34
	TDRT0500	50	1,39	2,00	2,46	2,95	3,56	0,41
	TDRT0630	63	2,14	3,11	3,92	4,70	5,63	0,48
	TDRT0750	75	2,97	4,46	5,62	6,65	7,89	0,66
	TDRT0900	90	4,10	5,85	7,20	8,73	10,35	0,87
	TDRT1100	110	4,89	7,08	8,79	10,70	12,93	1,22
	TDRT1250	125	6,41	9,12	11,17	13,65	16,64	1,46
	TDRT1400	140	8,03	11,49	14,22	17,14	20,87	1,78
	TDRT1600	160	10,39	15,07	18,65	22,37	27,24	2,29
	TDRT1800	180	12,95	18,79	23,99	28,33	33,86	2,98
	TDRT2000	200	15,91	23,30	29,02	34,97	42,47	3,20
	TDRT2250	225	20,14	29,28	36,64	44,35	53,79	5,03
	TDRT2500	250	25,27	36,35	44,82	54,45	65,37	5,54
	TDRT2800	280	31,37	45,44	56,54	68,57	82,51	8,05
	TDRT3150	315	39,48	58,00	70,77	87,00	104,97	9,91
	TDRT3550	355	52,23	77,22	94,50	116,68	133,82	13,59
TDRT4000	400	66,40	98,23	121,20	147,85	169,58	16,54	
TDRT5000	500	105,10	154,54	190,25	229,83	264,65		

Lenght / Longuer / Länge / Lunghezza / Longitud

PN	Diametro Diameter Ø	Lung Tubo / Pipe Lenght 3 mt	Lung. / Lenght. 5 mt	Lung. / Lenght. 6 mt
10	dal 16 al 110	X	X	X
	dal 125 al 500			X
16	dal 16 al 110		X	X
	dal 125 al 500			X

N.B.: Lung. max per spedizioni in container mt 5,80 / N.B.: Loading on container lenght 5,80 max

U-PVC Pipes grey / Tuyaux en PVC semi-rigides / Halbstarres graues PVC-U Rohr / Tubo in PVC-U Semirigido Grigio / Tubos en PVC semi-rigidos

	Code / Codice	d	PFA	Q.tà min / Min. q.ty	Box	Pack / Imballo	€
	TDRTSR_20X16	20x16	7	50 mt			On request
	TDRTSR_25X20	25x20	7	50 mt			On request
	TDRTSR_32X26	32x26	5	50 mt			On request
	TDRTSR_40X34	40x34	5	50 mt			On request
	TDRTSR_50X43	50x43	5	50 mt			On request
	TDRTSR_63X55	63x55	5	25 mt			On request
	TDRTSR_75X65	75x65	4	25 mt			On request
	TDRTSR_90X80	90x80	4	25 mt			On request
	TDRTSR_110X100	110x100	3	25 mt			On request
	TDRTSR_125X110	125x110	3	25 mt			On request

U-PVC Pipes whiteRohr / Tuyaux en PVC blanc "PLUS" / Halbstarres weißes PVC-U "PLUS" Rohr / Tubo in PVC-U Semirigido Bianco "PLUS" / Tubos en PVC semi-rigidos blancos

	Code / Codice	d	PFA	Q.tà min / Min. q.ty	Box	Pack / Imballo	€
	TDRTSRPLUS_50X42	50x42	5	50 mt			On request
	TDRTSRPLUS_63X55	63x55	5	25 mt			On request

PVC Manfold / Collecteur à 3 Entrées en Pvc / PVC 3-Wege verteiles Rohr / Collettore di Distribuzione a 3 Vie PVC / Colector 3 vías en PVC

	Code / Codice	d	PN / PFA	Q.tà min / Min. q.ty	Box	Pack / Imballo	€
	RDRCLD050F	50 x 40 x 50	16		1	M	42,78
	RDRCLD063F	63 x 40 x 50	16		1	M	68,05
	RDRCLD063G	63 x 50 x 63	16		1	M	68,05

Flowmeters / Débitmètres / Durchflussmesser Flussimetri / Caudalímetro

Working Operation

The flow meter operates on the float principle and is used for flow rate measurements in closed pipelines. The medium flows through the vertically installed flow meter from bottom to top. This raises the float and shows the current flow rate on the scale on the measuring device. The read-off edge corresponds to the largest diameter of the float.

The flow meters come as standard with a water scale and a % scale, and two set-point indicators.

Special features

- Fracture-proof and corrosion-resistant
- Radially removable
- Special adhesive scales for liquid and gaseous media
- Holder for accessories (limit value contacts)
- Measuring tube carries the DN label, and also the measuring range and material
- PVDF floats and stops as standard
- Measuring ranges 1.5 – 15.000 l/h

Funzionamento

Il flussimetro funziona sul principio del galleggiante e viene utilizzato per misure di portata in tubazioni chiuse. Il fluido scorre attraverso il flussimetro installato in verticale dal basso verso l'alto. Così facendo solleva il galleggiante e mostra la portata corrente sulla scala del dispositivo di misurazione.

I misuratori di portata sono equipaggiati di serie con una scala indicante la portata e una scala indicante la %, e due indicatori set-point.

Caratteristiche

- Resistente alla corrosione e agli urti
- Rimovibile radialmente
- Scale di portata speciali per liquidi e sostanze gassose
- Supporto per accessori
- Tubo graduato con indicazione della portata e del DN
- Galleggianti e Stops in PVDF come standard
- Range di misura 1.5 – 15000 l/h

Flowmeter with Transparent PVC-U Body and PVDF Float / Débitmètres avec le corps Transparent et Flottant en PVC-u
Durchflussmesser mit U-PVC transparentem Körper und Schwimmenden
Flussimetri con Corpo in PVC-U Trasparente e Galleggiante / Caudalímetro con cuerpo en PVC-u transparente y flotante

HDR



Code Codice	Description / Descrizione	L	Lm	€
HDRFLU016A	Flussimetro M123 PVC - Ø16 mm - Portata 1.5-15 L/h	165	199	99,24
HDRFLU016B	Flussimetro M123 PVC - Ø16 mm - Portata 2.5-25 L/h	165	199	99,24
HDRFLU016C	Flussimetro M123 PVC - Ø16 mm - Portata 5-50 L/h	165	199	99,24
HDRFLU016D	Flussimetro M123 PVC - Ø16 mm - Portata 10-100 L/h	165	199	99,24
HDRFLU020A	Flussimetro M123 PVC - Ø20 mm - Portata 8-80 L/h	185	223	101,85
HDRFLU020B	Flussimetro M123 PVC - Ø20 mm - Portata 15-150 L/h	185	223	101,85
HDRFLU020C	Flussimetro M123 PVC - Ø20 mm - Portata 20-200 L/h	185	223	101,85
HDRFLU032AE	Flussimetro M123 PVC - Ø32 mm - Portata 15-150 L/h	200	250	119,79
HDRFLU032BC	Flussimetro M123 PVC - Ø32 mm - Portata 30-300 L/h	200	250	119,79
HDRFLU032C	Flussimetro M350 PVC - Ø32 mm - Portata 50-500 L/h	350	400	150,93
HDRFLU032CC	Flussimetro M123 PVC - Ø32 mm - Portata 50-500 L/h	200	250	119,79
HDRFLU032D	Flussimetro M350 PVC - Ø32 mm - Portata 100-1000 L/h	350	400	153,69
HDRFLU040A	Flussimetro M350 PVC - Ø40 mm - Portata 150-1500 L/h	350	408	175,92
HDRFLU040B	Flussimetro M350 PVC - Ø40 mm - Portata 250-2500 L/h	350	408	189,81
HDRFLU050A	Flussimetro M350 PVC - Ø50 mm - Portata 200-2000 L/h	350	418	196,26
HDRFLU050B	Flussimetro M350 PVC - Ø50 mm - Portata 300-3000 L/h	350	418	262,95
HDRFLU050C	Flussimetro M350 PVC - Ø50 mm - Portata 600-6000 L/h	350	418	282,45
HDRFLU063B	Flussimetro M350 PVC - Ø63 mm - Portata 600-6000 L/h	350	432	327,81
HDRFLU063C	Flussimetro M350 PVC - Ø63 mm - Portata 1000-10000 L/h	350	432	352,77
HDRFLU063D	Flussimetro M350 PVC - Ø63 mm - Portata 1500-15000 L/h	350	432	387,06

PVC-u Ball Valves

Vannes à Boisseau Sphérique en PVC-u

PVC-u Kugelhähne / Valvole a Sfera in PVC-u

Válvulas de Bola en PVC-u



Industrial Ball Valves / Vannes à Boisseau Sphérique pour Industrie Kugelhähne Industrie / Valvole a Sfera per Industria / Válvulas de Bola para Industria

BK Range / Serie BK / Serie BK / Serie BK / Serie BK

Double Union Solvent Cement / Union double à coller / Radial mit Klebemuffen / Radiale con attacchi per incollaggio / Válvula de bola encolable

	Code / Codice EPDM	€	Code / Codice FKM	€	d	PN / PFA	Q.tà min Min. q.ty	Box	Pack Imballo
BK1D 	BDRBK1D0160	25,79	BDRBK1D016V	34,21	16	16		50	M
	BDRBK1D0200	26,36	BDRBK1D020V	34,70	20	16		50	M
	BDRBK1D0250	32,25	BDRBK1D025V	41,53	25	16		20	M
	BDRBK1D0320	38,32	BDRBK1D032V	50,50	32	16		20	M
	BDRBK1D0400	49,21	BDRBK1D040V	64,74	40	16		14	M
	BDRBK1D0500	62,91	BDRBK1D050V	82,28	50	16		14	M
	BDRBK1D0630	78,00	BDRBK1D063V	102,63	63	16		5	M
	BDRBK1D0750	171,02	BDRBK1D075V	224,82	75	10		1	M
	BDRBK1D0900	219,42	BDRBK1D090V	282,67	90	10		1	M
	BDRBK1D1100	305,74	BDRBK1D110V	383,67	110	10		1	M

Double Union , BSP, threaded / Union double à manchons taraudés BSP / BSP Radial IG / Radiale con attacchi filettati BSP / Válvula de Bola Roscada BSP

	Code / Codice EPDM	€	Code / Codice FKM	€	Rp (UNI EN 10226)	PN / PFA	Q.tà min Min. q.ty	Box	Pack Imballo
BK1E 	BERBK1E016A	28,72	BERBK1E016V	37,72	3/8"	16		50	M
	BERBK1E020B	30,00	BERBK1E020V	38,99	1/2"	16		50	M
	BERBK1E025C	36,22	BERBK1E025V	44,94	3/4"	16		20	M
	BERBK1E032D	42,51	BERBK1E032V	55,89	1"	16		20	M
	BERBK1E040E	55,10	BERBK1E040V	70,53	1 1/4"	16		14	M
	BERBK1E050F	69,79	BERBK1E050V	91,23	1 1/2"	16		14	M
	BERBK1E063G	88,34	BERBK1E063V	116,49	2"	16		5	M
	BERBK1E075H	185,96	BERBK1E075V	234,59	2 1/2"	10		1	M
	BERBK1E090I	248,46	BERBK1E090V	300,58	3"	10		1	M
	BERBK1E110L	311,00	BERBK1E110V	400,77	4"	10		1	M

Double Union BS / Union Double à manchons BS / BS Radial / Radiale con attacchi BS / Válvula de bola BS

	Code / Codice EPDM	€	Code / Codice FKM	€	d	PN / PFA	Q.tà min Min. q.ty	Box	Pack Imballo
BK1A 	BARBK1A0160	25,79	BARBK1A016V	34,21	3/8"	16		50	M
	BARBK1A0200	26,36	BARBK1A020V	34,70	1/2"	16		50	M
	BARBK1A0250	32,25	BARBK1A025V	41,53	3/4"	16		20	M
	BARBK1A0320	38,32	BARBK1A032V	50,50	1"	16		20	M
	BARBK1A0400	49,21	BARBK1A040V	64,74	1 1/4"	16		14	M
	BARBK1A0500	62,91	BARBK1A050V	82,28	1 1/2"	16		14	M
	BARBK1A0630	78,00	BARBK1A063V	102,63	2"	16		5	M
	BARBK1A0750	171,02	BARBK1A075V	224,82	2 1/2"	10		1	M
	BARBK1A0900	219,42	BARBK1A090V	282,67	3"	10		1	M
	BARBK1A1100	305,74	BARBK1A110V	383,67	4"	10		1	M

Flanged Double Union Solvent Cement / Union Double avec Brides / Radial mit Losflansche / Flange Folli / Bidas Locas

	Code / Codice EPDM	€	Code / Codice FKM	€	d	DN	PN / PFA	Q.tà min Min. q.ty	Box	Pack Imballo
BK1F 	BDRBK1F0200	48,29	BDRBK1F020V	58,62	20	15	16		1	M
	BDRBK1F0250	57,68	BDRBK1F025V	68,22	25	20	16		1	M
	BDRBK1F0320	68,17	BDRBK1F032V	80,45	32	25	16		1	M
	BDRBK1F0400	87,22	BDRBK1F040V	106,89	40	32	16		1	M
	BDRBK1F0500	113,93	BDRBK1F050V	138,47	50	40	16		1	M
	BDRBK1F0630	142,19	BDRBK1F063V	173,09	63	50	16		1	M
	BDRBK1F0750	273,27	BDRBK1F075V	340,07	75	65	10		1	M
	BDRBK1F0900	356,98	BDRBK1F090V	435,80	90	80	10		1	M
	BDRBK1F1100	461,85	BDRBK1F110V	559,00	110	100	10		1	M

HDPE Spigots for Electrofusion or Butt Weld / Manchon PEHD pour Soudure par Electrofusion ou Boût-à-Boût / HDPE Stutzen für Elektroschweißen oder Stumpschweißen
Manicotti in PEAD per Elettrofusione o Saldatura Testa a Testa / Manguito en PEAD para Electrofusión o Soldadura a Tope

	Code / Codice	d	PN / PFA	Q.tà min / Min. q.ty	Box	Pack / Imballo	€
BK1P 	BDRBK1P0200	20	16		1	M	55,51
	BDRBK1P0250	25	16		1	M	64,58
	BDRBK1P0320	32	16		1	M	76,13
	BDRBK1P0400	40	16		1	M	109,90
	BDRBK1P0500	50	16		1	M	131,06
	BDRBK1P0630	63	16		1	M	163,83
	BDRBK1P0750	75	10		1	M	296,53
	BDRBK1P0900	90	10		1	M	364,91
	BDRBK1P1100	110	10		1	M	468,07

BX/SX Range / Série BX/SX / Serie BX/SX / Serie BX/SX / Serie BX/SX

Double union metric / Union double métrique / Radial mit Klebemuffen / Radiale con attacchi per incollaggio / Válvula de bola para encolar

	Code / Codice	d	PN / PFA	Q.tà min / Min. q.ty	Box	Pack / Imballo	€
	BDRBXD0160	16	16		50	S	19,14
	BDRBXD0200	20	16		50	S	19,37
	BDRBXD0250	25	16		30	S	22,27
	BDRBXD0320	32	16		50	M	27,14
	BDRBXD0400	40	16		30	M	35,47
	BDRBXD0500	50	16		20	M	43,99
	BDRBXD0630	63	16		12	M	56,51
	BDRBXD0750	75	10		3	M	124,33
	BDRBXD0900	90	10		3	M	159,79
	BDRBXD1100	110	10		2	M	207,46

Double union, BSP, threaded / Union double à manchons taraudés / Radial IG / Radiale con attacchi filettati / Válvula de Bola Roscada

	Code / Codice	Rp (UNI EN 10226)	PN / PFA	Q.tà min / Min. q.ty	Box	Pack / Imballo	€
	BERBXE016A	3/8"	16		50	S	21,11
	BERBXE020B	1/2"	16		50	S	21,27
	BERBXE025C	3/4"	16		30	S	24,54
	BERBXE032D	1"	16		50	M	29,90
	BERBXE040E	1 1/4"	16		30	M	38,87
	BERBXE050F	1 1/2"	16		20	M	48,43
	BERBXE063G	2"	16		12	M	62,16
	BERBXE075H	2 1/2"	10		3	M	136,75
	BERBXE090I	3"	10		3	M	176,19
	BERBXE110L	4"	10		2	M	228,06

Double union BS / Union double à manchons BS / BS Radial / Radiale con attacchi BS / Válvula de bola BS

	Code / Codice	d	PN / PFA	Q.tà min / Min. q.ty	Box	Pack / Imballo	€
	BARBXA0160	3/8"	16		50	S	19,14
	BARBXA0200	1/2"	16		50	S	19,37
	BARBXA0250	3/4"	16		30	S	22,27
	BARBXA0320	1"	16		50	M	27,14
	BARBXA0400	1 1/4"	16		30	M	35,47
	BARBXA0500	1 1/2"	16		20	M	43,99
	BARBXA0630	2"	16		12	M	56,51
	BARBXA0750	2 1/2"	10		3	M	124,33
	BARBXA0900	3"	10		3	M	159,79
	BARBXA1100	4"	10		2	M	207,46

Flanged double union solvent cement / Union double avec brides / Radial mit Losflanschen / Flange folli / Bidas locas

	Code / Codice	d	DN	PN / PFA	Q.tà min / Min. q.ty	Box	Pack / Imballo	€
	BDRBXF0200	20	15	16		1	S	47,34
	BDRBXF0250	25	20	16		1	S	56,55
	BDRBXF0320	32	25	16		1	M	66,82
	BDRBXF0400	40	32	16		1	M	85,50
	BDRBXF0500	50	40	16		1	M	111,70
	BDRBXF0630	63	50	16		1	M	139,40
	BDRBXF0750	75	65	10		1	M	267,89
	BDRBXF0900	90	80	10		1	M	349,94
	BDRBXF1100	110	100	10		1	M	452,76

HDPE Spigots for electrofusion or butt weld / Manchon PEHD pour soudure par electrofusion ou Bouët-à-Bouët / HDPE Stutzen für Elektroschweißen oder Stumpschweißen
Manicotti in PEAD per elettro fusione o saldatura testa a testa / Manguito en PEAD para Electro fusión o Soldadura a Tope

	Code / Codice	d	PN / PFA	Q.tà min / Min. q.ty	Box	Pack / Imballo	€
	BDRBXP0200	20	16		1	S	28,71
	BDRBXP0250	25	16		1	S	32,39
	BDRBXP0320	32	16		1	M	38,00
	BDRBXP0400	40	16		1	M	47,26
	BDRBXP0500	50	16		1	M	60,34
	BDRBXP0630	63	16		1	M	74,54
	BDRBXP0750	75	10		3	M	157,92
	BDRBXP0900	90	10		1	M	199,64
	BDRBXP1100	110	10		1	M	282,51

Single union metric / Union simple métrique / Kugelhahn mit einseitiger Verschraubung / Monoghiera con attacchi per incollaggio / Válvula de bola con una unión para encolar

	Code / Codice	d	PN / PFA	Q.tà min / Min. q.ty	Box	Pack / Imballo	€
	BDRSXD0200	20	16		60	S	15,47
	BDRSXD0250	25	16		40	S	17,85
	BDRSXD0320	32	16		60	M	21,65
	BDRSXD0400	40	16		40	M	28,37
	BDRSXD0500	50	16		20	M	35,15
	BDRSXD0630	63	16		12	M	45,20
	BDRSXD0750	75	10		4	M	99,54
	BDRSXD0900	90	10		4	M	127,76
	BDRSXD1100	110	10		2	M	165,81

Single union, BSP threaded / Union simple à manchons taraudés / Kugelhahn mit einseitiger Verschraubung IG
Monoghiera con attacchi filettati / Válvula de una unión Roscada BSP

	Code / Codice	Rp (UNI EN 10226)	PN / PFA	Q.tà min / Min. q.ty	Box	Pack / Imballo	€
	BERSXE020B	1/2"	16		60	S	17,07
	BERSXE025C	3/4"	16		40	S	19,60
	BERSXE032D	1"	16		60	M	23,79
	BERSXE040E	1 1/4"	16		40	M	31,18
	BERSXE050F	1 1/2"	16		20	M	38,75
	BERSXE063G	2"	16		12	M	49,73
	BERSXE075H	2 1/2"	10		4	M	109,46
	BERSXE090I	3"	10		4	M	140,57
	BERSXE110L	4"	10		4	M	182,36

*Available with FKM seals / *Disponibile con guarnizioni in FKM

3 Way Ball Valves / Vannes 3 Voies / 3 Wege Kugelhähne Valvole a 3 Vie / Válvulas de 3 Viás

3 Way Ball Valve L Port / Vannes 3 voies L BS / 3 Wege Kugelhahn L Bohrung / Valvole a 3 Vie L BS / Válvulas de 3 viás L BS

	Code / Codice	d	€	Code / Codice	Rp (UNI EN 10226)	€	PN / PFA	Q.tà min Min. q.ty	Box	Pack Imballo
BTD-L BTE-L	BDRBTD025L	25	79,25	BERBTE025L	3/4"	84,83	10		10	M
	BDRBTD032L	32	88,06	BERBTE032L	1"	90,21	10		10	M
	BDRBTD050L	50	132,33	BERBTE050L	1 1/2"	132,33	10		10	M
	BDRBTD063L	63	175,26	BERBTE063L	2"	175,26	10		10	M



3 Way Ball Valve T Port / Vannes 3 voies T / 3 Wege Kugelhahn T Bohrung / Valvole a 3 Vie T / Válvulas de 3 viás T

	Code / Codice	d	€	Code / Codice	Rp (UNI EN 10226)	€	PN / PFA	Q.tà min Min. q.ty	Box	Pack Imballo
BTD-T BTE-T	BDRBTD025T	25	79,25	BERBTE025T	3/4"	84,83	10		10	M
	BDRBTD032T	32	88,06	BERBTE032T	1"	90,21	10		10	M
	BDRBTD050T	50	132,33	BERBTE050T	1 1/2"	132,33	10		10	M
	BDRBTD063T	63	176,65	BERBTE063T	2"	175,26	10		10	M



Water Ball Valves / Vannes à Boisseau Sphérique Kugelhähne Wasser / Valvole a Sfera / Válvulas de Bola

BV Range / Série BV / Serie BV / Serie BV / Serie BV

Double union, metric solvent cement / Double union femelle à coller / Radial mit Klebemuffen
Radiale con attacchi per incollaggio / Válvula de bola para encolar

	Code / Codice	d	PN / PFA	Q.tà min / Min. q.ty	Box	Pack / Imballo	€
	BDRBVD0160	16	16		50	S	9,69
	BDRBVD0200	20	16		50	S	9,69
	BDRBVD0250	25	16		30	S	10,88
	BDRBVD0320	32	16		50	M	14,24
	BDRBVD0400	40	16		30	M	19,22
	BDRBVD0500	50	16		20	M	22,06
	BDRBVD0630	63	16		12	M	33,27
	BDRBVD0750	75	10		3	M	107,88
	BDRBVD0900	90	10		3	M	141,18
	BDRBVD1100	110	10		2	M	185,61

Double union, BSP, threaded / Double union taraudée / Radial IG / Radiale con attacchi filettati / Válvula de bola Roscada

	Code / Codice	Rp (UNI EN 10226)	PN / PFA	Q.tà min / Min. q.ty	Box	Pack / Imballo	€
	BERBVE016A	3/8"	16		50	S	10,23
	BERBVE020B	1/2"	16		50	S	10,23
	BERBVE025C	3/4"	16		30	S	10,71
	BERBVE032D	1"	16		50	M	15,25
	BERBVE040E	1 1/4"	16		30	M	19,59
	BERBVE050F	1 1/2"	16		20	M	22,36
	BERBVE063G	2"	16		12	M	35,19
	BERBVE075H	2 1/2"	10		3	M	110,73
	BERBVE090I	3"	10		3	M	147,23
	BERBVE110L	4"	10		2	M	194,03

Double union BS solvent cement / Double union BS à coller / Radial BS / Radiale con attacchi BS / Válvula de bola BS

	Code / Codice	d	PN / PFA	Q.tà min / Min. q.ty	Box	Pack / Imballo	€
	BARBVA0160	3/8"	16		50	S	9,69
	BARBVA0200	1/2"	16		50	S	9,69
	BARBVA0250	3/4"	16		30	S	10,23
	BARBVA0320	1"	16		50	M	14,27
	BARBVA0400	1 1/4"	16		30	M	18,23
	BARBVA0500	1 1/2"	16		20	M	21,02
	BARBVA0630	2"	16		12	M	34,10
	BARBVA0750	2 1/2"	10		3	M	107,88
	BARBVA0900	3"	10		3	M	141,18
	BARBVA1100	4"	10		2	M	185,61

ASTM / NPT / JIS

Double Union ASTM / Union Double ASTM / Kugelhahn ASTM / Radiale ASTM / Válvula de bola ASTM

	Code / Codice	d	PN / PFA	Q.tà min / Min. q.ty	Box	Pack / Imballo	€
	BSRBVS0200	20	16		50	S	10,61
	BSRBVS0250	25	16		30	S	11,09
	BSRBVS0320	32	16		50	M	14,94
	BSRBVS0400	40	16		30	M	19,59
	BSRBVS0500	50	16		20	M	23,05
	BSRBVS0630	63	16		12	M	34,76
	BSRBVS0750	75	10		3	M	109,98
	BSRBVS0900	90	10		3	M	143,93
	BSRBVS1100	110	10		2	M	189,21

Double Union NPT Threaded / Union Double NPT taraudée / Kugelhahn NPT / Radiale Filetto NPT / Válvula de Bola Roscada NPT

	Code / Codice	d	PN / PFA	Q.tà min / Min. q.ty	Box	Pack / Imballo	€
	BNRBVN020B	1/2"	16		50	S	12,26
	BNRBVN025C	3/4"	16		30	S	12,48
	BNRBVN032D	1"	16		50	M	15,93
	BNRBVN040E	1 1/4"	16		30	M	19,97
	BNRBVN050F	1 1/2"	16		20	M	23,36
	BNRBVN063G	2"	16		12	M	36,77
	BNRBVN075H	2 1/2"	10		3	M	112,88
	BNRBVN090I	3"	10		3	M	150,08
	BNRBVN110L	4"	10		2	M	197,79

Double Union JIS / Union Double JIS / Kugelhahn JIS / Radiale JIS / Válvula de bola JIS

	Code / Codice	d	PN / PFA	Q.tà min / Min. q.ty	Box	Pack / Imballo	€
	BJRBVJ0200	20	16		50	S	9,73
	BJRBVJ0250	25	16		30	S	11,09
	BJRBVJ0320	32	16		50	M	14,94
	BJRBVJ0400	40	16		30	M	19,59
	BJRBVJ0500	50	16		20	M	23,05
	BJRBVJ0630	63	16		12	M	34,76
	BJRBVJ0750	75	10		3	M	109,98
	BJRBVJ0900	90	10		3	M	143,93
	BJRBVJ1100	110	10		2	M	189,21

SV Range / Série SV / Serie SV / Serie SV / Serie SV

Single Union Metric / Union simple métrique / Kugelhahn mit einseitiger Verschraubung
Monoghiera con attacchi per incollaggio / Válvula de bola con una unión para encolar

	Code / Codice	d	PN / PFA	Q.tà min / Min. q.ty	Box	Pack / Imballo	€
	BDRSVD0200	20	16		60	S	8,54
	BDRSVD0250	25	16		40	S	8,54
	BDRSVD0320	32	16		60	M	9,53
	BDRSVD0400	40	16		30	M	12,69
	BDRSVD0500	50	16		20	M	17,19
	BDRSVD0630	63	16		12	M	28,41
	BDRSVD0750	75	10		4	M	62,68
	BDRSVD0900	90	10		4	M	72,54
	BDRSVD1100	110	10		2	M	128,14

Single union, BSP threaded / Union simple à manchons taraudés / Kugelhahn mit einseitiger Verschraubung IG
Monoghiera con attacchi filettati / Válvula con una unión roscada BSP

	Code / Codice	Rp (UNI EN 10226)	PN / PFA	Q.tà min / Min. q.ty	Box	Pack / Imballo	€
	BERSVE020B	1/2"	16		60	S	9,04
	BERSVE025C	3/4"	16		40	S	9,04
	BERSVE032D	1"	16		60	M	10,76
	BERSVE040E	1 1/4"	16		30	M	14,06
	BERSVE050F	1 1/2"	16		20	M	20,21
	BERSVE063G	2"	16		12	M	30,00
	BERSVE075H	2 1/2"	10		4	M	72,66
	BERSVE090I	3"	10		4	M	88,76
	BERSVE110L	4"	10		2	M	138,62

Single Union, BS, solvent cement / Union Simple à Collier BS / Kugelhahn mit einseitiger Verschraubung BS
Monoghiera con attacchi per incollaggio BS / Válvula de bola con una unión para encolar BS

	Code / Codice	d	PN / PFA	Q.tà min / Min. q.ty	Box	Pack / Imballo	€
	BARSVA0200	1/2"	16		60	S	8,59
	BARSVA0250	3/4"	16		40	S	8,59
	BARSVA0320	1"	16		60	M	10,04
	BARSVA0400	1 1/4"	16		40	M	13,08
	BARSVA0500	1 1/2"	16		20	M	19,49
	BARSVA0630	2"	16		12	M	29,97
	BARSVA0750	2 1/2"	10		4	M	64,55
	BARSVA0900	3"	10		4	M	74,74
	BARSVA1100	4"	10		2	M	131,99

Single union, BSP, threaded M-F / Simple union taraudée M-F / Einseitig lösbar mit Gewindemuffen AG-IG
Monoghiera con attacchi filettati maschio-femmina / Válvula de bola Roscada Hembra-Macho

	Code / Codice	Rp x R (UNI EN 10226)	PN / PFA	Q.tà min / Min. q.ty	Box	Pack / Imballo	€
	BQRSVQ020B	1/2" x 1/2"	16		60	S	9,19
	BQRSVQ025C	3/4" x 3/4"	16		40	S	9,58
	BQRSVQ032D	1" x 1"	16		60	M	10,23
	BQRSVQ040E	1 1/4" x 1 1/4"	16		30	M	14,06
	BQRSVQ050F	1 1/2" x 1 1/2"	16		20	M	18,92
	BQRSVQ063G	2" x 2"	16		12	M	30,74

Single Union Ball Valve plain socket compression joint / Simple union avec attaques à compression / Kugelhahn mit Klemmeverbinder
Valvola monoghiera con attacco compressione / Válvula salida PE

	Code / Codice	Rp (UNI EN 10226) x d	PN / PFA	Q.tà min / Min. q.ty	Box	Pack / Imballo	€
	BERSGE020B	1/2" x 20	16		100	M	10,34
	BERSGE025C	3/4" x 25	16		50	M	11,52
	BERSGE032D	1" x 32	16		40	M	12,80
	BERSGE050F	1 1/2" x 50	16		15	M	43,92
	BERSGE063G	2" x 63	16		10	M	53,37

Double union ball valve with compression joints / Double union avec attaques à compression / Kugelhahn mit Klemmeverbindern
Valvola bighiera con attacchi a compressione / Válvula de bola PE

	Code / Codice	d	PN / PFA	Q.tà min / Min. q.ty	Box	Pack / Imballo	€
	BDRBBG0500	50	10		10	M	48,10
	BDRBBG0630	63	10		5	M	65,04

Check Valves / Soupapes / Rückschlagventile Valvole di Non Ritorno / Válvulas Antiretorno

Double union, metric solvent cement / Union double métrique à coller / Kugelrückschlagventile / Radiale con attacchi per incollaggio / Válvula de bola Antiretorno

	Code / Codice EPDM	€	Code / Codice FKM	€	d	PN / PFA	Q.tà min Min. q.ty	Box	Pack Imballo
	CDRCVD0200	13,34	CDRCVD020V	18,94	20	16		60	S
	CDRCVD0250	16,01	CDRCVD025V	21,95	25	16		40	S
	CDRCVD0320	17,16	CDRCVD032V	23,80	32	16		60	M
	CDRCVD0400	20,20	CDRCVD040V	27,88	40	16		40	M
	CDRCVD0500	29,37	CDRCVD050V	38,50	50	16		24	M
	CDRCVD0630	38,87	CDRCVD063V	51,21	63	16		13	M
	CDRCVD0750	91,53	CDRCVD075V	126,21	75	10		3	M
	CDRCVD0900	118,23	CDRCVD090V	163,11	90	10		3	M
	CDRCVD1100	184,02	CDRCVD110V	282,70	110	10		2	M

Double union, BSP threaded / Union double à manchons taraudés BSP / BSP Kugelrückschlagventile IG / Radiale con attacchi filettati BSP / Válvula de Bola Roscada BSP

	Code / Codice EPDM	€	Code / Codice FKM	€	Rp (UNI EN 10226)	PN / PFA	Q.tà min Min. q.ty	Box	Pack Imballo
	CERCVE020B	14,56	CERCVE020V	20,18	1/2"	16		60	S
	CERCVE025C	17,39	CERCVE025V	23,32	3/4"	16		40	S
	CERCVE032D	18,51	CERCVE032V	25,18	1"	16		60	M
	CERCVE040E	21,50	CERCVE040V	29,32	1 1/4"	16		40	M
	CERCVE050F	30,74	CERCVE050V	40,05	1 1/2"	16		24	M
	CERCVE063G	40,43	CERCVE063V	52,75	2"	16		13	M
	CERCVE075H	97,93	CERCVE075V	132,70	2 1/2"	10		3	M
	CERCVE090I	126,16	CERCVE090V	171,12	3"	10		3	M
	CERCVE110L	164,74	CERCVE110V	214,88	4"	10		2	M

Double union, BS solvent Cement / Union Double Métrique à Coller BS / Kugelrückschlagventile BS / Radiale con attacchi per incollaggio BS / Válvula de Bola Antiretorno BS

	Code / Codice EPDM	€	Code / Codice FKM	€	d	PN / PFA	Q.tà min Min. q.ty	Box	Pack Imballo
	CARCA0200	13,34	CARCA020V	18,94	1/2"	16		60	S
	CARCA0250	16,01	CARCA025V	21,95	3/4"	16		40	S
	CARCA0320	17,16	CARCA032V	23,80	1"	16		60	M
	CARCA0400	20,20	CARCA040V	27,88	1 1/4"	16		40	M
	CARCA0500	29,37	CARCA050V	38,50	1 1/2"	16		24	M
	CARCA0630	38,87	CARCA063V	51,21	2"	16		13	M
	CARCA0750	91,53	CARCA075V	126,21	2 1/2"	10		3	M
	CARCA0900	118,23	CARCA090V	163,11	3"	10		3	M
	CARCA1100	184,02	CARCA110V	282,70	4"	10		2	M

Clear solvent cement check valve with stainless steel spring / Soupapes double union transparente à coller et ressort en acier inox / Kugelrückschlagventil mit durchsichtigem Körper und Feder in Edelstahl / Valvola di non ritorno bighiera trasparente con manicotti a incollaggio e molla in acciaio inox / Válvula de bola antiretorno transparente y muelle en acero inox

	Code / Codice EPDM	d	PFA	Q.tà min Min. q.ty	Box	Pack Imballo	€
	CDRCVT0200	20	16		60	S	18,76
	CDRCVT0250	25	16		40	S	21,73
	CDRCVT0320	32	16		60	M	23,57
	CDRCVT0400	40	16		40	M	27,62
	CDRCVT0500	50	16		24	M	38,13
	CDRCVT0630	63	16		13	M	50,72
	CDRCVT0750	75	10		3	M	125,00
	CDRCVT0900	90	10		3	M	161,54

PTFE Coated Spring / Résort en PTFE / PTFE Feder / Molla Rivestita in PTFE / Muelle Recubierto de PTFE

Double union, metric solvent cement / Union double métrique à coller / Kugelrückschlagventil / Radiale con attacchi per incollaggio / Válvula de bola Antiretorno

	Code / Codice EPDM	€	Code / Codice FKM	€	d	PN / PFA	Q.tà min Min. q.ty	Box	Pack Imballo
	CDRCVDT0200	22,02	CDRCVDT020V	27,47	20	16		60	S
	CDRCVDT0250	24,62	CDRCVDT025V	30,43	25	16		40	S
	CDRCVDT0320	25,75	CDRCVDT032V	32,23	32	16		60	M
	CDRCVDT0400	30,03	CDRCVDT040V	37,50	40	16		40	M
	CDRCVDT0500	39,25	CDRCVDT050V	48,12	50	16		24	M
	CDRCVDT0630	50,21	CDRCVDT063V	62,14	63	16		13	M
	CDRCVDT0750	104,43	CDRCVDT075V	138,24	75	10		3	M
	CDRCVDT0900	131,38	CDRCVDT090V	175,13	90	10		3	M

Double union, BSP threaded / Union double à manchons taraudés / Kugelrückschlagventil IG / Radiale con attacchi filettati / Válvula de Bola Antiretorno BSP

	Code / Codice EPDM	€	Code / Codice FKM	€	Rp (UNI EN 10226)	PN / PFA	Q.tà min Min. q.ty	Box	Pack Imballo
	CERCVET020B	23,25	CERCVET020V	28,73	1/2"	16		60	S
	CERCVET025C	26,01	CERCVET025V	31,79	3/4"	16		40	S
	CERCVET032D	27,15	CERCVET032V	33,62	1"	16		60	M
	CERCVET040E	31,33	CERCVET040V	38,96	1 1/4"	16		40	M
	CERCVET050F	40,65	CERCVET050V	49,66	1 1/2"	16		24	M
	CERCVET063G	51,75	CERCVET063V	63,70	2"	16		13	M
	CERCVET075H	110,90	CERCVET075V	144,71	2 1/2"	10		3	M
	CERCVET090I	139,40	CERCVET090V	183,14	3"	10		3	M

PTFE Coated Spring / Résort en PTFE / PTFE Feder / Molla Rivestita in PTFE / Muelle Recubierto de PTFE

Double union, BS solvent cement / Union double métrique à coller BS / Kugelrückschlagventile BS / Radiale con attacchi per incollaggio BS / Válvula de bola para encolar BS

	Code / Codice EPDM	€	Code / Codice FKM	€	d	PN / PFA	Q.tà min Min. q.ty	Box	Pack Imballo
CVA-T 	CARCVAT0200	21,81	CARCVAT020V	27,47	1/2"	16		60	S
	CARCVAT0250	24,38	CARCVAT025V	30,43	3/4"	16		40	S
	CARCVAT0320	25,51	CARCVAT032V	32,23	1"	16		60	M
	CARCVAT0400	29,74	CARCVAT040V	37,50	1 1/4"	16		40	M
	CARCVAT0500	38,87	CARCVAT050V	48,12	1 1/2"	16		24	M
	CARCVAT0630	49,73	CARCVAT063V	62,14	2"	16		13	M
	CARCVAT0750	103,42	CARCVAT075V	138,23	2 1/2"	10		3	M
	CARCVAT0900	130,12	CARCVAT090V	175,13	3"	10		3	M

Ball Check Valve / Soupape a Bille / Kugelrückschlagventil Valvola di non Ritorno a Palla / Válvula Antiretorno De Purga

Y check valves with ball solvent sockets / Soupape Y avec manchons à bille à coller / Y Kugelrückschlagventil mit Klebemuffen
Valvola di ritegno a palla mod. Y manicotti incollaggio / Válvula antiretorno de purga Y con manguitos encolables

	Code / Codice	d	PFA	Q.tà min / Min. q.ty	Box	Pack / Imballo	€
CPD 	CDRCPD0160.T	16			1		29,82
	CDRCPD0200.T	20			1		29,82
	CDRCPD0250.T	25			1		33,95
	CDRCPD0320.T	32			1		54,25
	CDRCPD0400.T	40			1		61,13
	CDRCPD0500.T	50			1		83,90
	CDRCPD0630.T	63			1		120,93
	CDRCPD0750.T	75			1		235,57
	CDRCPD0900.T	90			1		346,64

Y check valves with ball threaded sockets / Soupape Y avec manchons taraudés / Y Kugelrückschlagventil mit Gewindemuffen
Valvola di ritegno a palla mod. Y manicotti filettati / Válvula antiretorno de purga Y con manguitos roscados

	Code / Codice	d	PFA	Q.tà min / Min. q.ty	Box	Pack / Imballo	€
CPE 	CERCPE016A.T	3/8"			1		33,10
	CERCPE020B.T	1/2"			1		37,27
	CERCPE025C.T	3/4"			1		42,44
	CERCPE032D.T	1"			1		60,22
	CERCPE040E.T	1" 1/4			1		67,85
	CERCPE050F.T	1" 1/2			1		93,13
	CERCPE063G.T	2"			1		134,23
	CERCPE075H.T	2" 1/2			1		261,48
	CERCPE090I.T	3"			1		384,77

Air Release Valves / Ventouse / Be u. Entlüftungsventile Valvole Sfogo Aria / Válvula de Purga

Double union, metric solvent cement / Union double métrique à coller / Be- und Entlüftungsventil / Radiale con attacchi per incollaggio / Válvula de purga

	Code / Codice	d	PN / PFA	Q.tà min / Min. q.ty	Box	Pack / Imballo	€
AVD 	CDRAVD0200	20	16		60	S	13,05
	CDRAVD0250	25	16		40	S	15,63
	CDRAVD0320	32	16		60	M	16,77
	CDRAVD0400	40	16		40	M	18,30
	CDRAVD0500	50	16		24	M	26,92
	CDRAVD0630	63	16		13	M	35,32
	CDRAVD0750	75	10		3	M	85,43
	CDRAVD0900	90	10		3	M	110,98
	CDRAVD1100	110	10		2	M	146,22

Air Release Valves / Ventouse / Be u. Entlüftungsventile Valvole Sfogo Aria / Válvula de Purga

Double union, BSP threaded / Union double à manchons taraudés BSP / BSP Be-und Entlüftungsventil IG / Radiale con attacchi filettati BSP / Válvula de purga en PVC roscada BSP

	Code / Codice	Rp (UNI EN 10226)	PN / PFA	Q.tà min / Min. q.ty	Box	Pack / Imballo	€
	CERAVE020B	1/2"	16		60	S	14,19
	CERAVE025C	3/4"	16		40	S	17,00
	CERAVE032D	1"	16		60	M	18,07
	CERAVE040E	1 1/4"	16		40	M	19,73
	CERAVE050F	1 1/2"	16		24	M	28,29
	CERAVE063G	2"	16		13	M	36,99
	CERAVE075H	2 1/2"	10		3	M	91,76
	CERAVE090I	3"	10		3	M	118,98
	CERAVE110L	4"	10		2	M	182,08

Double union, BS solvent cement / Union double métrique à coller BS / Be-und Entlüftungsventil BS / Radiale con attacchi per incollaggio BS / Válvula de purga en PVC roscada BS

	Code / Codice	d	PN / PFA	Q.tà min / Min. q.ty	Box	Pack / Imballo	€
	CARAVA0200	1/2"	16		60	S	13,05
	CARAVA0250	3/4"	16		40	S	15,63
	CARAVA0320	1"	16		60	M	16,77
	CARAVA0400	1 1/4"	16		40	M	18,30
	CARAVA0500	1 1/2"	16		24	M	26,92
	CARAVA0630	2"	16		13	M	35,32
	CARAVA0750	2 1/2"	10		3	M	85,43
	CARAVA0900	3"	10		3	M	110,98
	CARAVA1100	4"	10		2	M	190,40

Foot Valves / Vannes a Pié / Fußventile Valvole di Fondo / Válvulas de Pie

Double union, metric solvent cementing / Union double métrique à coller / Fußventil / Radiale con attacchi per incollaggio / Válvula de pie

	Code / Codice	d	PN / PFA	Q.tà min / Min. q.ty	Box	Pack / Imballo	€
	CDRHVD0200	20	16		60	S	11,44
	CDRHVD0250	25	16		40	S	14,02
	CDRHVD0320	32	16		60	M	14,68
	CDRHVD0400	40	16		40	M	16,61
	CDRHVD0500	50	16		24	M	25,39
	CDRHVD0630	63	16		13	M	33,03
	CDRHVD0750	75	10		3	M	80,39
	CDRHVD0900	90	10		3	M	107,08
	CDRHVD1100	110	10		2	M	140,02

Double union, BSP, threaded / Union double à manchons taraudés BSP / Fußventil IG / Radiale con attacchi filettati / Válvula de pie roscada

	Code / Codice	Rp (UNI EN 10226)	PN / PFA	Q.tà min / Min. q.ty	Box	Pack / Imballo	€
	CERHVE020B	1/2"	16		60	S	12,58
	CERHVE025C	3/4"	16		40	S	15,40
	CERHVE032D	1"	16		60	M	15,96
	CERHVE040E	1 1/4"	16		40	M	18,07
	CERHVE050F	1 1/2"	16		24	M	26,77
	CERHVE063G	2"	16		13	M	34,69
	CERHVE075H	2 1/2"	10		3	M	86,72
	CERHVE090I	3"	10		3	M	115,09
	CERHVE110L	4"	10		2	M	172,56

Double union, BS solvent cementing / Union double métrique a coller BS / Fußventil BS / Radiale con attacchi per incollaggio BS / Válvula de pie BS

	Code / Codice	d	PN / PFA	Q.tà min / Min. q.ty	Box	Pack / Imballo	€
	CARHVA0200	1/2"	16		60	S	11,44
	CARHVA0250	3/4"	16		40	S	14,02
	CARHVA0320	1"	16		60	M	14,68
	CARHVA0400	1 1/4"	16		40	M	16,61
	CARHVA0500	1 1/2"	16		24	M	25,39
	CARHVA0630	2"	16		13	M	33,03
	CARHVA0750	2 1/2"	10		3	M	77,93
	CARHVA0900	3"	10		3	M	107,08
	CARHVA1100	4"	10		2	M	181,83

Inclined-Seat Valves / Vanne à Soupape à Tête Inclinée Schrägsitzventile / Valvola a Sede Inclinata / Valvola Asiento Inclinado

Manual shut-off valves / Vanne à fermeture manuelle / Handabsperrentile / Valvola a chiusura manuale / Valvola con cierre manual

	Code / Codice	d	PN / PFA	Q.tà min / Min. q.ty	Box	Pack / Imballo	€
VIV 	CDRVIV0200	20			1		113,84
	CDRVIV0250	25			1		123,40
	CDRVIV0320	32			1		144,42
	CDRVIV0400	40			1		186,91
	CDRVIV0500	50			1		212,50
	CDRVIV0630	63			1		280,91

Non return valves / Clapet de retenue / Rückschlagventil / Valvola di ritegno / Valvola antiretorno

	Code / Codice	d	PN / PFA	Q.tà min / Min. q.ty	Box	Pack / Imballo	€
VIS 	CDRVIS0200	20			1		83,97
	CDRVIS0250	25			1		101,27
	CDRVIS0320	32			1		119,62
	CDRVIS0400	40			1		155,27
	CDRVIS0500	50			1		182,38
	CDRVIS0630	63			1		250,62

Sediment strainer / Filtre à tamis / Schmutzfänger / Raccoglitori di impurità / Colector de impurezas

	Code / Codice	d	PN / PFA	Q.tà min / Min. q.ty	Box	Pack / Imballo	€
VIT 	CDRVIT0200	20			1		68,68
	CDRVIT0250	25			1		79,49
	CDRVIT0320	32			1		97,59
	CDRVIT0400	40			1		128,06
	CDRVIT0500	50			1		185,71
	CDRVIT0630	63			1		221,70

Sightglass / Indicateur de Flux / Wasserlauf Anzeiger Indicatore di Flusso / Medidor de Flujo

Sightglass with PVC-u union / Indicateur de Flux avec PVC-u union / Wasserlauf Anzeiger mit PVC-u Verschraubung Indicatore di Flusso con bocchettone in PVC-u / Medidor de Flujo con unión en PVC-u

	Code / Codice	d	PN / PFA	Q.tà min / Min. q.ty	Box	Pack / Imballo	€
IND 	RDRIND0500	50					37,49
	RDRIND0630	63					41,24

Swing Check Valve / Clapet à Battant Rückschlagklappe / Valvola a Clapet / Válvula de Clapeta

PATENTED

Swing check valve / Clapet à battant / Rückschlagklappe / Valvola a clapet / Válvula de clapeta

Code / Codice	d	DN	PN / PFA	Q.tà min / Min. q.ty	Box	Pack / Imballo	€
CKD 	CDRCKD0750	75	65	10	5	S	56,60
	CDRCKD0900	90	80	10	5	S	68,55
	CDRCKD1100	110	100	10	4	S	84,86
	CDRCKD1400	140	125	10	1	S	103,76
	CDRCKD1600	160	150	6	1	S	111,40

ANSI and DIN System

PATENTED

Swing check valve with spring / Clapet à battant avec ressort / Rückschlagklappe mit Feder / Valvola a clapet con molla / Válvula de clapeta con muelle

Code / Codice	d	DN	PN / PFA	Q.tà min / Min. q.ty	Box	Pack / Imballo	€
CKD.M EPDM 	CDRCKD0750.M	75	65	10	5	S	65,09
	CDRCKD0900.M	90	80	10	5	S	78,83
	CDRCKD1100.M	110	100	10	4	S	97,58
	CDRCKD1400.M	140	125	10	1	S	119,30
	CDRCKD1600.M	160	150	6	1	S	128,85

Swing check valve / Clapet à battant / Rückschlagklappe / Valvola a clapet / Válvula de clapeta

Code / Codice	d	DN	PN / PFA	Q.tà min / Min. q.ty	Box	Pack / Imballo	€
CKD 	CDPCKD0630	63	50	10	10	S	53,93
	CDPCKD1250	125	110	10	10	S	93,53
	CDPCKD2000	200	200	6	10	S	142,77
	CDPCKD2250	225	200	6	10	S	162,33

Swing check valve / Clapet à battant / Rückschlagklappe / Valvola a clapet / Válvula de clapeta

Code / Codice	d	DN	PN / PFA	Q.tà min / Min. q.ty	Box	Pack / Imballo	€
CKT 	CDPCKT0320	32		10	1		15,97
	CDPCKT0400	40		10	1		18,35
	CDPCKT0500	50		10	1		23,44
	CDPCKT0630	63		10	1		25,80

Metric Gate Valve / Vannes à Guillotine / Absperrschieber Valvola a Ghigliottina / Válvula de Guillotina

Metric gate valve with plastic paddles / Vanne à guillotine avec palettes en plastique / Absperrschieber mit Kunststoff-Paddeln
Valvola a ghigliottina con palette in plastica / Válvula de guillotina con paletes en plástico

Code / Codice	d	DN	PN / PFA	Q.tà min / Min. q.ty	Box	Pack / Imballo	€
BGD 	BDRBGD0500	50		6	30	M	8,99
	BDRBGD0630	63		6	20	M	13,43
	BDRBGD0750	75		6	26	L	22,06
	BDRBGD0900	90		6	16	L	43,12
	BDRBGD1100	110		6	12	L	52,21
	BDRBGD1600	160		6	12	L	129,05

Metric gate valves with stainless steel paddles / Vanne à guillotine avec palettes en acier inoxydable / Absperrschieber mit Edelstahl-Paddeln
Valvola a ghigliottina con palette in acciaio inossidabile / Válvula de guillotina con paletes de acero inoxidable

Code / Codice	d	DN	PN / PFA	Q.tà min / Min. q.ty	Box	Pack / Imballo	€
BGD.SS 	BDRBGD110.SS	110			6	L	70,28
	BDRBGD160.SS	160			1	L	293,65
	BDRBGD200.SS	200			1	L	410,43
	BDRBGD250.SS	250			1	L	562,91

Butterfly Valves / Vannes à Papillon Absperrklappen Valvole a Farfalla / Válvulas de Mariposa



Butterfly Valves / Vannes à Papillon / Absperrenklappen Valvole a Farfalla / Válvulas de Mariposa

PROFLOW H Series - Hand operated butterfly valve with EPDM seals / PROFLOW H Série - Vanne à papillon avec poignée et joints en EPDM
PROFLOW H Reihe - Handbediente Wasser Absperrenklappe mit EPDM Dichtungen
PROFLOW Serie H - Valvola a farfalla con maniglia e guarnizioni in EPDM / PROFLOW H Serie - Válvula de mariposa con maneta y juntos en EPDM

New Patent Pending

	Code / Codice	Descrizione/Description	d	DN	PFA	Gua / Seal	O'ring	Asta/Stem	€
PFH EPDM	FDRPFH0750	ProFlow Serie H PVC-U	75	65	10	EPDM	EPDM	ZN Plated Carbon Steel	136,52
	FDRPFH0900	ProFlow Serie H PVC-U	90	80	10	EPDM	EPDM	ZN Plated Carbon Steel	154,82
	FDRPFH1100	ProFlow Serie H PVC-U	110	100	10	EPDM	EPDM	ZN Plated Carbon Steel	169,06
	FDRPFH1400*	ProFlow Serie H PVC-U	125-140	125	10	EPDM	EPDM	ZN Plated Carbon Steel	189,02
	FDRPFH1600*	ProFlow Serie H PVC-U	160	150	10	EPDM	EPDM	ZN Plated Carbon Steel	232,24
	FDRPFH2250*	ProFlow Serie H PVC-U	200-225	200	6	EPDM	EPDM	ZN Plated Carbon Steel	398,46

Optional a richiesta/Optional on request: Volantino/box gear – flangiata/flanged

Hand operated butterfly valve with EPDM seals / Vanne à papillon avec poignée et joints en EPDM
Handbediente Absperrenklappe mit Dichtungen in EPDM / Valvola a farfalla con maniglia e guarnizioni in EPDM
Válvula de mariposa con maneta y juntos en EPDM

	Code / Codice EPDM	Inches	d	DN	PFA	Q.tà min Min. q.ty	Box	Pack Imballo	€
FVD EPDM	FDRFVD1250	5"	125	125	10		2	S	219,04
	FDRFVD1400	5"	140	125	10		2	S	232,42
	FDRFVD1600	6"	160	150	6		1	S	278,15
	FDRFVD2000	8"	200	200	6		1	S	365,30
	FDRFVD2500	10"	250	250	6		1	L	931,10
	FDRFVD3150	12"	315	300	6		1	L	3.229,86

Available also flanged and/or with FKM seals / Disponibili anche flangiata e/o con guarnizioni in FPM

PROFLOW P Series - Hand operated industry butterfly valve with EPDM seals / PROFLOW P Série - Vanne à papillon série industrie avec poignée et joints en EPDM
PROFLOW P Reihe - Handbediente Industrie Absperrenklappe mit Dichtungen in EPDM
PROFLOW Serie P - Valvola a farfalla Industria con maniglia e guarnizioni in EPDM / PROFLOW P - Serie Válvula de mariposa serie industria con maneta y juntos en EPDM

New Patent Pending

	Code / Codice	Descrizione/Description	Ø	DN	Gua/Seal	O'ring	Asta/Stem	€
PFP EPDM	FDRPFP0750	ProFlow Serie P PVC-U	75	65	EPDM	EPDM	SS AISI 316	244,32
	FDRPFP0900	ProFlow Serie P PVC-U	90	80	EPDM	EPDM	SS AISI 316	265,94
	FDRPFP1100	ProFlow Serie P PVC-U	110	100	EPDM	EPDM	SS AISI 316	298,32
	FDRPFP1400*	ProFlow Serie P PVC-U	125-140	125	EPDM	EPDM	SS AISI 316	322,34
	FDRPFP1600*	ProFlow Serie P PVC-U	160	150	EPDM	EPDM	SS AISI 316	395,86
	FDRPFP2250*	ProFlow Serie P PVC-U	200-225	200	EPDM	EPDM	SS AISI 316	548,56

Optional a richiesta/Optional on request: Volantino/Handwheel – flangiata/flanged

PROFLOW P Series - Hand operated industry butterfly valve with FKM seals / PROFLOW P Série - Vanne à papillon série industrie avec poignée et joints en FKM
PROFLOW P Reihe - Handbediente Industrie Absperrenklappe mit Dichtungen in FKM
PROFLOW Serie P - Valvola a farfalla Industria con maniglia e guarnizioni in FKM / PROFLOW P - Válvula de mariposa serie industria con maneta y juntos en FKM

New Patent Pending

	Code / Codice	Descrizione/Description	Ø	DN	Gua/Seal	O'ring	Asta/Stem	€
PFP FKM	FDRPFP075V	ProFlow Serie P PVC-U	75	65	FKM	FKM	SS AISI 316	324,68
	FDRPFP090V	ProFlow Serie P PVC-U	90	80	FKM	FKM	SS AISI 316	398,88
	FDRPFP110V	ProFlow Serie P PVC-U	110	100	FKM	FKM	SS AISI 316	482,12
	FDRPFP140V*	ProFlow Serie P PVC-U	125-140	125	FKM	FKM	SS AISI 316	502,12
	FDRPFP160V*	ProFlow Serie P PVC-U	160	150	FKM	FKM	SS AISI 316	665,82
	FDRPFP225V*	ProFlow Serie P PVC-U	200-225	200	FKM	FKM	SS AISI 316	967,78

Optional a richiesta/Optional on request: Volantino/Handwheel – flangiata/flanged

Flat Gaskets / Joint plât / Flachdichtung / Guarnizione piana / Junta plana

	Code / Codice	d	PN / PFA	Q.tà min / Min. q.ty	Box	Pack / Imballo	€
GQG	RGRGQG0500	50					1,10
	RGRGQG0630	63					1,25
	RGRGQG0750	75					1,67
	RGRGQG0900	90					1,98
	RGRGQG1100	110					2,25
	RGRGQG1250	125					2,51
	RGRGQG1400	140					2,89
	RGRGQG1600	160					3,28
RGRGQG2000	200					4,36	

* Available later this year / * Disponibili in corso dell'anno

New
Patent Pending

PROFLOW H Series - Hand operated butterfly valve with EPDM seals flanged / PROFLOW H Série - Vanne à papillon avec poignée et joints en EPDM bridée
PROFLOW H Reihe - Handbediente Wasser Absperrklappe mit EPDM Dichtungen mit Flanschen
PROFLOW Serie H - Valvola a farfalla con maniglia e guarnizioni in EPDM flangiata / PROFLOW H Serie - Válvula de mariposa con maneta y juntos en EPDM con bridas

PFHV
EPDM



Code / Codice	Descrizione/Description	d	DN	PFA	Gua / Seal	O'ring	Asta/Stem	€
FDRPFHF0750	ProFlow Serie H PVC-U	75	65	10	EPDM	EPDM	ZN Plated Carbon Steel	185,32
FDRPFHF0900	ProFlow Serie H PVC-U	90	80	10	EPDM	EPDM	ZN Plated Carbon Steel	225,82
FDRPFHF1100	ProFlow Serie H PVC-U	110	100	10	EPDM	EPDM	ZN Plated Carbon Steel	239,49
FDRPFHF1400	ProFlow Serie H PVC-U	125-140	125	10	EPDM	EPDM	ZN Plated Carbon Steel	298,43
FDRPFHF1600	ProFlow Serie H PVC-U	160	150	10	EPDM	EPDM	ZN Plated Carbon Steel	328,10
FDRPFHF2250	ProFlow Serie H PVC-U	200-225	200	6	EPDM	EPDM	ZN Plated Carbon Steel	457,89

Optional a richiesta/Optional on request: Volantino/box gear – flangiata/flanged

New
Patent Pending

PROFLOW P Series - Hand operated industry butterfly valve with EPDM seals flanged/ PROFLOW P Série - Vanne à papillon série industrie avec poignée et joints en EPDM bridée
PROFLOW P Reihe - Handbediente Industrie Absperrklappe mit Dichtungen in EPDM mit Flanschen
PROFLOW Serie P - Valvola a farfalla Industria con maniglia e guarnizioni in EPDM flangiata / PROFLOW P - Serie Válvula de mariposa serie industria con maneta y juntos en EPDM con bridas

PFPV
EPDM



Code / Codice	Descrizione/Description	Ø	DN	Gua/Seal	O'ring	Asta/Stem	€
FDRPFPF0750 FVF	ProFlow Serie P PVC-U	75	65	EPDM	EPDM	SS AISI 316	294,52
FDRPFPF0900 FVF	ProFlow Serie P PVC-U	90	80	EPDM	EPDM	SS AISI 316	336,82
FDRPFPF1100 FVF	ProFlow Serie P PVC-U	110	100	EPDM	EPDM	SS AISI 316	377,12
FDRPFPF1400 FVF	ProFlow Serie P PVC-U	140	125	EPDM	EPDM	SS AISI 316	404,02
FDRPFPF1600 FVF	ProFlow Serie P PVC-U	160	150	EPDM	EPDM	SS AISI 316	485,86
FDRPFPF2250 FVF	ProFlow Serie P PVC-U	200	200	EPDM	EPDM	SS AISI 316	668,33

Optional a richiesta/Optional on request: Volantino/Handwheel – flangiata/flanged

Actuated Ball Valves / Vannes Motorisées
Kugelhähne mit Antrieb
Valvole Attuate / Válvulas con Actuador



Actuated Ball Valves / Vannes Motorisées / Kugelhähne mit Antrieb Valvole Attuate / Válvulas con Actuador

Electrically Actuated / Commande Électrique / Elektroantrieb Attuatore Elettrico / Con Actuador Electrico

Solvent cement electrically actuated double union ball valve / Vannes à bille à coller électriques / Radial mit Klebemuffen und Elektroantrieb
Valvola a sfera bighiera con manicotti ad incollaggio a comando elettrico / Válvulas de bola para encolar eléctricas

Code / Codice 12v	€	Code / Codice 24/240v	€	d	PFA	Q.tà min Min. q.ty	Box	Pack Imballo
EBK1 * EPDM								
BDREBK1JA0160	582,60	BDREBK1YA0160	582,60	16	16		1	
BDREBK1JA0200	582,60	BDREBK1YA0200	582,60	20	16		1	
BDREBK1JA0250	589,10	BDREBK1YA0250	589,10	25	16		1	
BDREBK1JA0320	602,89	BDREBK1YA0320	602,89	32	16		1	
BDREBK1JA0400	616,70	BDREBK1YA0400	616,70	40	16		1	
BDREBK1JA0500	682,42	BDREBK1YA0500	682,42	50	16		1	
BDREBK1JA0630	701,07	BDREBK1YA0630	701,07	63	16		1	
BDREBK1JA0750	1.080,85	BDREBK1YA0750	1.080,85	75	10		1	
BDREBK1JA0900	1.131,16	BDREBK1YA0900	1.131,16	90	10		1	
BDREBK1JA1100	1.249,63	BDREBK1YA1100	1.249,63	110	10		1	



* Available female threaded and BS - Available with FKM seals / Disponibile con manicotti filettati e BS a richiesta - Disponibile con guarnizione FKM

Pneumatically Actuated / Commande Pnéumatique / Pneumatikantrieb Comando Pneumatico / Con Actuador Neumático

Solvent cement pneumatically actuated single or double acting ball valve / Vannes à bille à coller pneumatiques singles où double effect
Radial mit Klebemuffen und Doppel- oder Einfachwirkend / Valvola a sfera bighiera con manicotti a incollaggio con attuatore pneumatico
singolo o doppio effetto / Válvulas de bola para encolar con actuador neumático simple o doble

Code / Codice Single acting / Singolo effetto	€	Code / Codice Double acting / doppio effetto	€	d	PFA	Q.tà min Min. q.ty	Box	Pack Imballo
PBK-1D * PBK-1S *								
BDRPBK1016D	390,31	BDRPBK1016S	486,87	16	16		1	
BDRPBK1020D	390,31	BDRPBK1020S	486,87	20	16		1	
BDRPBK1025D	392,32	BDRPBK1025S	493,36	25	16		1	
BDRPBK1032D	403,27	BDRPBK1032S	512,02	32	16		1	
BDRPBK1040D	409,77	BDRPBK1040S	513,62	40	16		1	
BDRPBK1050D	430,88	BDRPBK1050S	534,74	50	16		1	
BDRPBK1063D	449,53	BDRPBK1063S	560,71	63	16		1	
BDRPBK1075D	708,38	BDRPBK1075S	888,55	75	10		1	
BDRPBK1090D	952,12	BDRPBK1090S	1.206,61	90	10		1	
BDRPBK1110D	1.154,67	BDRPBK1110S	1.484,13	110	10		1	



Actuation Kit / Kit pour actuation / Kit für Antrieb / Kit per attuazione / Kit para actuación

Code / Codice	Description / Descrizione	€
KITB		
BDRKITB10200	Nylon + PVC Support + Bolts also for 16 mm / utilizzabile anche per 16 mm.	25,11
BDRKITB10250	Nylon + PVC Support + Bolts	25,68
BDRKITB10320	Nylon + PVC Support + Bolts	26,13
BDRKITB10400	Nylon + PVC Support + Bolts	26,52
BDRKITB10500	Nylon + PVC Support + Bolts	27,33
BDRKITB10630	Nylon + PVC Support + Bolts	27,71
BDRKITB10900	Nylon + PVC Support + Bolts also for 75 mm / utilizzabile anche per 75 mm.	41,53
BDRKITB11100	Nylon + PVC Support + Bolts	42,48



Base for actuation / Base pour actuation / Antriebsbasis / Base per attuatore / Base para actuación

Code / Codice	Description / Descrizione	€
Base for actuation / Base per attuatore		
BDR1BASE	PA630GF modular base for 20-63 valves base modulare in PA630GF per valvole 20-63	on request
BDR1BASF0900	PA630GF base for 75-90 valves base in PA630GF per valvole 75-90 mm	on request
BDR1BASF1100	PA630GF base for 110 valves base in PA630GF per valvole 110 mm	on request



* Available female threaded and BS - Available with FKM seals / Disponibile con manicotti filettati e BS a richiesta - Disponibile con guarnizione FKM

Electrically Actuated Butterfly Valve / Vanne à Papillon à Commande Electrique / Absperklappe mit Elektroantrieb Valvola a Farfalla a Comando Elettrico / Válvula de Mariposa con Actuador Eléctrico

New Patent Pending

PROFLOW H Series - Electrically actuated butterfly valve with EPDM seals / PROFLOW H Série - Vannes à papillon électriques avec joints en EPDM
PROFLOW H Reihe - Absperklappe mit Elektroantrieb und EPDM Dichtungen
PROFLOW Serie H - Valvola a farfalla a comando elettrico con guarnizione in EPDM / PROFLOW H - Válvulas de mariposa eléctrica con juntos en EPDM

Code / Codice 12V	€	Code / Codice 24-240V	€	d	DN	PFA	Gua / Seal	O'ring	Asta/Stem
FDREPFH0750	922,88	FDREPFHY0750	922,88	75	65	10	EPDM	EPDM	ZN Plated Carbon Steel
FDREPFH0900	967,31	FDREPFHY0900	967,31	90	80	10	EPDM	EPDM	ZN Plated Carbon Steel
FDREPFH1100	994,61	FDREPFHY1100	994,61	110	100	10	EPDM	EPDM	ZN Plated Carbon Steel
FDREPFH1400*	1.198,22	FDREPFHY1400*	1.198,22	125-140	125	10	EPDM	EPDM	ZN Plated Carbon Steel
FDREPFH1600*	1.346,09	FDREPFHY1600*	1.346,09	160	150	10	EPDM	EPDM	ZN Plated Carbon Steel
FDREPFH2250*	1.723,43	FDREPFHY2250*	1.723,43	200-225	200	6	EPDM	EPDM	ZN Plated Carbon Steel

Optional / Optional: flangiata / Flanged

New Patent Pending

PROFLOW P Series - Electrically actuated butterfly valve with EPDM seals / PROFLOW P Série - Vannes à papillon électriques avec joints en EPDM
PROFLOW P Reihe - Absperklappe mit Elektroantrieb und EPDM Dichtungen
PROFLOW Serie P - Valvola a farfalla a comando elettrico con guarnizione in EPDM / PROFLOW P - Válvulas de mariposa eléctrica con juntos en EPDM

Code / Codice 12V	€	Code / Codice 24-240V	€	d	DN	PFA	Gua / Seal	O'ring	Asta/Stem
FDREPPF0750	1.189,85	FDREPPFY0750	1.189,85	75	65	10	EPDM	EPDM	SS AISI 316
FDREPPF0900	1.259,13	FDREPPFY0900	1.259,13	90	80	10	EPDM	EPDM	SS AISI 316
FDREPPF1100	1.290,77	FDREPPFY1100	1.290,77	110	100	10	EPDM	EPDM	SS AISI 316
FDREPPF1400*	1.522,12	FDREPPFY1400*	1.522,12	125-140	125	10	EPDM	EPDM	SS AISI 316
FDREPPF1600*	1.682,61	FDREPPFY1600*	1.682,61	160	150	10	EPDM	EPDM	SS AISI 316
FDREPPF2250*	2.024,68	FDREPPFY2250*	2.024,68	200-225	200	6	EPDM	EPDM	SS AISI 316

Optional a richiesta / Optional on request : - FKM Seals / Guarnizioni in FKM; flangiata / flanged

Electrically actuated butterfly valve with EPDM seals / Vannes à papillon électriques avec joints en EPDM / Absperklappe mit Elektroantrieb und EPDM Dichtungen / Valvola a farfalla a comando elettrico con guarnizione in EPDM / Válvulas de mariposa eléctrica con juntos en EPDM

Code / Codice 12v	€	Code / Codice 24/240v	€	d	Inch	DN	PFA	Q.tà min Min. q.ty	Box	Pack Imballo
FDREFVJA1250	1.249,63	FDREFVYA1250	1.249,63	125	5"	125	10		1	
FDREFVJA1400	1.265,86	FDREFVYA1400	1.265,86	140	5"	125	10		1	
FDREFVJA1600	1.291,82	FDREFVYA1600	1.291,82	160	6"	150	6		1	
FDREFVJA2250	1.294,62	FDREFVYA2250	1.294,62	200-225	8"	200	6		1	
FDREFVJA3150	On request	FDREFVYA3150	On request	315	12"	315	6		1	

Optional a richiesta / Optional on request : - FKM Seals / Guarnizioni in FKM

* Available later this year / * Disponibili in corso dell'anno

Pneumatically Actuated Butterfly Valve / Vanne à Papillon à Commande Pneumatique / Absperklappe mit Pneumatiktrieb Valvola a Farfalla a Comando Pneumatico / Válvula de Mariposa con Actuador Neumático

New Patent Pending

PROFLOW H Series - Pneumatic actuated butterfly valve with EPDM seals / PROFLOW H Série - Vannes à papillon pneumatiques avec joints en EPDM
PROFLOW H Reihe - Absperklappe mit Pneumatiktrieb und EPDM Dichtungen
PROFLOW Serie H - Valvola a farfalla a comando pneumatico con guarnizione in EPDM / PROFLOW H - Válvulas de mariposa neumáticas con juntos en EPDM

Code Spring Return Cod. Semplice Effetto	€	Code Double Acting Codice Doppio Effetto	€	DN	PFA	Gua / Seal	O'ring	Asta/Stem
FDRPPFH075S	861,93	FDRPPFH075D	513,75	65	10	EPDM	EPDM	ZN Plated Carbon Steel
FDRPPFH090S	868,98	FDRPPFH090D	541,10	80	10	EPDM	EPDM	ZN Plated Carbon Steel
FDRPPFH110S	873,92	FDRPPFH110D	547,17	100	10	EPDM	EPDM	ZN Plated Carbon Steel
FDRPPFH140S*	912,23	FDRPPFH140D*	600,12	125	10	EPDM	EPDM	ZN Plated Carbon Steel
FDRPPFH160S*	1.192,90	FDRPPFH160D*	687,16	150	10	EPDM	EPDM	ZN Plated Carbon Steel
FDRPPFH225S*	1.302,67	FDRPPFH225D*	888,23	200	6	EPDM	EPDM	ZN Plated Carbon Steel

Optional a richiesta / Optional on request : - FKM Seals / Guarnizioni in FKM; flangiata / flanged.

* Available later this year / * Disponibili in corso dell'anno

Pneumatically Actuated Butterfly Valve / Vanne à Papillon à Commande Pneumatique / Absperrklappe mit Pneumatiktrieb / Valvola a Farfalla a Comando Pneumatico / Válvula de Mariposa con Actuador Neumático

New Patent Pending

PROFLOW P Series – Pneumatic actuated butterfly valve with EPDM seals / PROFLOW P Série - Vannes à papillon pneumatiques avec joints en EPDM
 PROFLOW P Reihe - Absperrklappe mit Pneumatiktrieb mit EPDM Dichtungen
 PROFLOW Serie P - Valvola a farfalla a comando pneumatico con guarnizione in EPDM / PROFLOW P - Válvulas de mariposa neumáticas con juntas en EPDM

Code Spring Return Cod. Semplice Effetto	€	Code Double Acting Codice Doppio Effetto	€	d	DN	PFA	Gua / Seal	O'ring	Asta/Stem
FDRPPF-P EPDM									
FDRPPF075S	1.077,41	FDRPPF075D	642,19	75	65	10	EPDM	EPDM	SS AISI 316
FDRPPF090S	1.086,22	FDRPPF090D	676,37	90	80	10	EPDM	EPDM	SS AISI 316
FDRPPF110S	1.092,40	FDRPPF110D	683,96	110	100	10	EPDM	EPDM	SS AISI 316
FDRPPF140S*	1.222,44	FDRPPF140D*	798,22	125-140	125	10	EPDM	EPDM	SS AISI 316
FDRPPF160S*	1.491,13	FDRPPF160D*	858,95	160	150	10	EPDM	EPDM	SS AISI 316
FDRPPF225S*	1.652,12	FDRPPF225D*	1.088,48	200-225	200	6	EPDM	EPDM	SS AISI 316



Optional a richiesta / Optional on request : – FKM Seals / Guarnizioni in FKM; flangiata / flanged.

Pneumatically actuated butterfly valve single or double acting / Vannes à papillon pneumatiques single ou double effect
 Absperrklappe mit Pneumatiktrieb – Einfach/Doppelwirkend
 Valvola a farfalla a comando pneumatico – Semplice effetto/Doppio effetto / Válvulas de mariposa neumáticas uno o doble efecto

Code / Codice EPDM	€	Code / Codice EPDM	€	Code / Codice FKM	d	Inch	DN	PFA	Q.tà min Min. q.ty	Box	Pack Imballo
PFV-D EPDM											
FDRPFV1250D	753,18	FDRPFV1250S	886,10	On request	125	5"	125	10		1	
FDRPFV1400D	775,26	FDRPFV1400S	912,06	On request	140	5"	125	10		1	
FDRPFV1600D	946,98	FDRPFV1600S	1.114,10	On request	160	6"	150	10		1	
FDRPFV2000D	1.219,45	FDRPFV2000S	1.457,37	On request	200-225	8"	200	6		1	



Optional a richiesta / Optional on request : – FKM Seals / Guarnizioni in FKM

* Available later this year / * Disponibili in corso dell'anno

Diaphragm Valve / Vanne a Membrane / Membranventile Valvola a Membrana / Válvula a Diafragma

Manually operated diaphragm valve / Vanne à Membrane Manuelle / Manual Membranventil / Valvola a membrana manuale / Válvula a Diafragma Manual

Code / Codice	d	PFA	Q.tà min / Min. q.ty	Box	Pack / Imballo	€
MVD						
MDRMVD0200	20	8		1		119,54
MDRMVD0250	25	8		1		133,33
MDRMVD0320	32	8		1		147,38
MDRMVD0400	40	6		1		207,46
MDRMVD0500	50	6		1		268,17
MDRMVD0630	63	6		1		299,58



Pneumatically actuated diaphragm valve / Vanne à Membrane Pneumatique / Pneumatisch Membranventil
 Valvola a membrana a comando pneumatico / Válvula a Diafragma Pneumatico

Code / Codice	d	PFA	Q.tà min / Min. q.ty	Box	Pack / Imballo	€
MPD						
MDRMVD0200	20	8		1		246,43
MDRMVD0250	25	8		1		263,36
MDRMVD0320	32	8		1		280,29
MDRMVD0400	40	6		1		414,35
MDRMVD0500	50	6		1		548,43
MDRMVD0630	63	6		1		613,76



Pneumatically actuated direct action diaphragm valve / Vanne à Membrane à Commande Pneumatique/ Pneumatisch Membranventil
 Valvola a membrana a comando pneumatico ad azione diretta / Válvula a Diafragma Pneumatico a Acción Directa

Code / Codice	d	PFA	Q.tà min / Min. q.ty	Box	Pack / Imballo	€
MMD-MME						
MDRMMD0400	40	6		1		46,27
MDRMMD0500	50	6		1		50,87
MDRMMD0630	63	6		1		58,38
MERMME032E	1" x 1 1/4"	6		1		46,91
MERMME040E	1 1/4" x 1 1/4"	6		1		57,81



Glue / Colle / Kleber / Colla / Cola

Glue / Colle / Kleber / Colla / Cola

Glue for Large Diameters / Colle pour Grands Diamètres

Kleber für große Durchmesser / Colla per Grandi Diametri / Cola para Grandes Diámetros

Solvent / Diluent / Reinigungsmittel / Solvente / Disolvente

PTFE Tape / Ruban en PTFE / Band aus PTFE / Nastro in PTFE / Banda en PTFE



Solvent Cement and Cleaner / Colle et Diluent Kleber und Reinigungsmittel / Colla e Diluente / Cola y Disolvente

Glue, PVC Cleaner and PTFE Tape / Colle, diluent et ruban en PTFE / Kleber, Reinigungsmittel und Band aus PTFE Colla, Detergente PVC e Nastro in Teflon (PTFE) / Cola, disolvente y banda en PTFE

Glue / Colle / Kleber / Colla / Cola

	Code / Codice	Size / Misura	Brush Pennello	Feature Aspetto	Colour Colore	Display Contenitore	Box	€
PLUMEFF	PLUMEFF1250	125 ml	•	Viscous / Viscoso	Blue/Blu	Plastic Bottle Bott. Plastica	24	6,78
	PLUMEFF2500	250 ml	•	Viscous / Viscoso	Blue/Blu	Plastic Bottle Bott. Plastica	24	9,31
	PLUMEFF5000	500 ml	•	Viscous / Viscoso	Blue/Blu	Plastic Bottle Bott. Plastica	12	18,30
	PLUMEFF1000	1000 ml	•	Viscous / Viscoso	Blue/Blu	Plastic Bottle Bott. Plastica	8	32,92



Effast-Tite is a solution of polyvinyl in a mixture of solvents containing tetrahydrofuran to cement PVC pipes and fittings developed with a special solvent that evaporates fast. When flexible pipes are cemented, please wait at least one hour. For immediate testing use maximum 3 bars after twenty minutes (up to 160 mm).

For flexible pipe joint waiting at last 1 hour

La colla Effast-Tite è una soluzione di polivinile in una miscela di solventi che contengono tetraidrofurano (TFH) per incollare tubi e raccordi in PVC sviluppata con un solvente speciale che evapora velocemente. Quando i tubi flessibili sono incollati aspettare un'ora per l'essiccazione. Per una prova immediata non usare più di 3 bar dopo 20 minuti (fino a 160 mm). Per incollaggi con tubi flessibili attendere almeno un'ora

Glue for large diameters / Colle pour grands diamètres / Kleber für große Durchmesser Colla per grandi diametri / Cola para grande diámetros

	Code / Codice	Size / Misura	Brush Pennello	Feature Aspetto	Colour Colore	Display Contenitore	Box	€
PLUMBIGS	PLUMBIGS0500	500 ml	•	Viscous / Viscoso	Blue/Blu	Plastic Bottle Bott. Plastica	12	20,14
	PLUMBIGS1000	1000 ml	•	Viscous / Viscoso	Blue/Blu	Plastic Bottle Bott. Plastica	8	36,24



Large-Tite is developed with special solvents that evaporate slowly. Pressure testing after 24h (above 10°). Do not use this solvent cement below 5°C, during the first 10 minutes do not charge mechanically.

Large-Tite è sviluppata con un solvente che evapora lentamente. Il test di pressione deve essere effettuato dopo 24 ore (sopra i 10°C), non usare questa colla sotto i 5°C, durante i primi 10 minuti non caricare meccanicamente.

Performance

Essential characteristics Caratteristiche essenziali	Performance	Standard reference Normativa di riferimento
Shear Strength		
At 1 hour setting time	≥ 0,4 MPa	
At 24 hour setting time	≥ 1,5 MPa	
At 480 + 96 (60oC) hour setting time	≥ 7,0 MPa	
applications for PN 16 (Nominal Pressure 16 bar)		EN 14814
Pressure resistance at 51,2 bar / 20 oC	≥ 1000 hour, no leakage	
Pressure resistance at 16 bar / 60 oC	≥ 1000 hour, no leakage	

Cleaner / Diluent / Reinigungsmittel / Detergente / Disolvente

Code / Codice	Size / Misura	Brush Pennello	Feature Aspetto	Colour Colore	Display Contenitore	Box	€	
PLUDET	PLUDET1000	1000 ml		Liquid / Liquido	Colourless Incolore	Plastic Bottle Bott. Plastica	6	19,62



Prepare surfaces of PVC pipes and fittings cleaning any residual dirt. Can be used with glue containing tetrahydrofuran.

Prepara le superfici dei tubi e dei raccordi in PVC pulendole da sporcizia residua. Può essere usato con colle che contengono tetraidrofurano (TFH).

PTFE Tape / Ruban en PTFE / Band aus PTFE / Nastro in PTFE / Banda en PTFE

Code / Codice	Size / Misura	PFA	Q,tà min Min. Q.ty	Box	€
PTFE	GGPTEF0120	12 MT x12 mm		10	1,95



ABS Fittings / Raccords en ABS
Klebefittings aus ABS
Raccordi in ABS / Accesorios en ABS



Solvent Cement Fittings BS / Raccordi à Coller BS / Klebefittings BS Raccordi Incollaggio BS / Accesorios para Encolar BS

Elbow 90° / Coude 90° / Winkel 90° / Gomito 90° / Codo 90°

	Code / Codice	d	PN / PFA	Q.tà min / Min. q.ty	Box	Pack / Imballo	€
A-GOA	RAAGOA0200	1/2"	15		250	M	1,11
	RAAGOA0250	3/4"	15		300	M	1,22
	RAAGOA0320	1"	15		180	M	1,42
	RAAGOA0400	1 1/4"	15		120	M	2,62
	RAAGOA0500	1 1/2"	15		120	L	3,53
	RAAGOA0630	2"	15		60	L	5,13
	RAAGOA0750	2 1/2"	15		40	L	11,55
	RAAGOA0900	3"	15		25	L	15,11
	RAAGOA1100	4"	15		13	L	22,26
	RAAGOA1400	5"	15		6	L	55,00
	RAAGOA1600	6"	15		4	L	84,17
	RAAGOA2250	8"	9		1	L	215,22

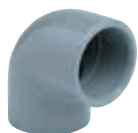

Elbow 45° / Coude 45° / Winkel 45° / Gomito a 45° / Codo 45°

	Code / Codice	d	PN / PFA	Q.tà min / Min. q.ty	Box	Pack / Imballo	€
A-GYA	RAAGYA0200	1/2"	15		300	S	1,69
	RAAGYA0250	3/4"	15		400	M	1,84
	RAAGYA0320	1"	15		200	M	2,49
	RAAGYA0400	1 1/4"	15		150	M	3,21
	RAAGYA0500	1 1/2"	15		150	L	4,06
	RAAGYA0630	2"	15		90	L	6,05
	RAAGYA0750	2 1/2"	15		50	L	11,67
	RAAGYA0900	3"	15		30	L	14,23
	RAAGYA1100	4"	15		16	L	30,61
	RAAGYA1600	6"	15		4	L	65,26
	RAAGYA2250	8"	9		1	L	251,56



Socket / Manchon / Muffe / Manicotto / Manguito

	Code / Codice	d	PN / PFA	Q.tà min / Min. q.ty	Box	Pack / Imballo	€
A-MAA	RAAMAA0200	1/2"	15		350	S	0,85
	RAAMAA0250	3/4"	15		400	M	0,92
	RAAMAA0320	1"	15		250	M	0,99
	RAAMAA0400	1 1/4"	15		180	M	1,61
	RAAMAA0500	1 1/2"	15		200	L	1,96
	RAAMAA0630	2"	15		100	L	2,87
	RAAMAA0750	2 1/2"	15		80	L	6,38
	RAAMAA0900	3"	15		45	L	10,78
	RAAMAA1100	4"	15		24	L	15,34
	RAAMAA1400	5"	15		12	L	31,36
	RAAMAA1600	6"	15		6	L	38,24
	RAAMAA2250	8"	9		2	L	124,37



Tee 90° / Tè 90° / T-Stück 90° / Ti 90° / Te 90°

	Code / Codice	d	PN / PFA	Q.tà min / Min. q.ty	Box	Pack / Imballo	€
A-TIA	RAATIA0200	1/2"	15		400	M	1,22
	RAATIA0250	3/4"	15		200	M	1,38
	RAATIA0320	1"	15		100	M	1,84
	RAATIA0400	1 1/4"	15		70	M	3,02
	RAATIA0500	1 1/2"	15		90	L	4,35
	RAATIA0630	2"	15		50	L	6,68
	RAATIA0750	2 1/2"	15		32	L	12,31
	RAATIA0900	3"	15		20	L	18,24
	RAATIA1100	4"	15		9	L	28,34
	RAATIA1400	5"	15		4	L	87,82
	RAATIA1600	6"	15		3	L	99,08
	RAATIA2250	8"	9		1	L	258,54

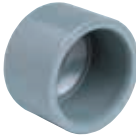

Cap / Bouchon / Kappe / Calotta / Tapón

	Code / Codice	d	PN / PFA	Q.tà min / Min. q.ty	Box	Pack / Imballo	€
A-CAA 	RAACAA0200	1/2"	15		500	S	0,85
	RAACAA0250	3/4"	15		350	S	0,99
	RAACAA0320	1"	15		400	S	1,14
	RAACAA0400	1 1/4"	15		250	M	1,61
	RAACAA0500	1 1/2"	15		180	M	2,21
	RAACAA0630	2"	15		100	M	2,96
	RAACAA0750	2 1/2"	15		60	M	7,23
	RAACAA0900	3"	15		65	L	9,81
	RAACAA1100	4"	15		40	L	26,39
	RAACAA1600	6"	15		10	L	36,73
	RAACAA2250	8"	9		6	L	134,17

Bend 90° / Courbe 90° / Bogen 90° / Curva 90° / Curva 90°

	Code / Codice	d	PN / PFA	Q.tà min / Min. q.ty	Box	Pack / Imballo	€
A-CUA 	RAACUA0200	1/2"	15		300	M	5,46
	RAACUA0250	3/4"	15		150	M	6,64
	RAACUA0320	1"	15		100	M	8,36
	RAACUA0400	1 1/4"	15		50	M	11,12
	RAACUA0500	1 1/2"	15		60	L	15,94
	RAACUA0630	2"	15		30	L	21,55
	RAACUA0750	2 1/2"	15		15	L	45,24
	RAACUA0900	3"	15		9	L	56,53
	RAACUA1100	4"					90,37

Union / Union 3 pièces / Verschraubung 3 Stk. / Bocchettone / Unión

	Code / Codice	d	PN / PFA	Q.tà min / Min. q.ty	Box	Pack / Imballo	€
A-BOA 	RAABOA0200	1/2"	15		150	S	3,55
	RAABOA0250	3/4"	15		200	M	4,01
	RAABOA0320	1"	15		120	M	5,40
	RAABOA0400	1 1/4"	15		80	M	6,82
	RAABOA0500	1 1/2"	15		60	M	8,80
	RAABOA0630	2"	15		30	M	12,35
	RAABOA0750	2 1/2"	15		30	L	37,46
	RAABOA0900	3"	15		25	L	43,90
	RAABOA1100	4"	15		15	L	50,83

Reducing bush / Réduction courte / Reduktion kurz / Riduzione corta / Reducción corta

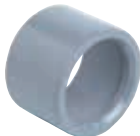
	Code / Codice	d	PN / PFA	Q.tà min / Min. q.ty	Box	Pack / Imballo	€
A-RCA 	RAARCA025B	3/4" x 1/2"	15		700	S	1,10
	RAARCA032B	1" x 1/2"	15		450	S	1,10
	RAARCA032C	1" x 3/4"	15		450	S	1,10
	RAARCA040D	1 1/4" x 1"	15		300	S	1,24
	RAARCA050C	1 1/2" x 3/4"	15		350	M	1,95
	RAARCA050D	1 1/2" x 1"	15		350	M	1,95
	RAARCA050E	1 1/2" x 1 1/4"	15		350	M	1,95
	RAARCA063D	2" x 1"	15		180	M	2,42
	RAARCA063E	2" x 1 1/4"	15		180	M	2,42
	RAARCA063F	2" x 1 1/2"	15		180	M	2,37
	RAARCA075F	2 1/2" x 1 1/2"	15		110	M	3,80
	RAARCA075G	2 1/2" x 2"	15		110	M	3,80
	RAARCA090F	3" x 1 1/2"	15		65	M	6,31
	RAARCA090G	3" x 2"	15		65	M	6,31
	RAARCA090H	3" x 2 1/2"	15		65	M	6,31
	RAARCA110G	4" x 2"	15		35	M	8,61
	RAARCA110I	4" x 3"	15		35	M	8,61
	RAARCA140L	5" x 4"	15		40	M	22,57
	RAARCA160L	6" x 4"	15		21	L	26,63

Stub flange (serrated face) / Collet strié / Bundbuchse gerillt / Collare rigato / Manguito portabridas

	Code / Codice	d	PN / PFA	Q.tà min / Min. q.ty	Box	Pack / Imballo	€
A-QRA 	RAAQRA0320	1"	15		200	S	1,16
	RAAQRA0500	1 1/2"	15		180	M	2,83
	RAAQRA0630	2"	15		90	M	4,58
	RAAQRA0750	2 1/2"	15		120	L	7,23
	RAAQRA0900	3"	15		70	L	8,85
	RAAQRA1100	4"	15		40	L	11,55
	RAAQRA1400	5"	15		20	L	26,93
	RAAQRA1600	6"	15		12	L	30,02
RAAQRA2250	8"	9		4	L	75,47	

Drilled Fixed Flange BS 10 / Bride Collet Perforée BS 10 / Festflansche BS 10 / Flangia Fissa Forata BS 10 / Brida Fija Perforada BS 10

	Code / Codice	d	PN / PFA	Q.tà min / Min. q.ty	Box	Pack / Imballo	€
A-FFA 	RAAFFA0200	1/2"	15		100	S	4,24
	RAAFFA0250	3/4"	15		60	S	4,58
	RAAFFA0320	1"	15		50	S	7,48
	RAAFFA0500	1 1/2"	15		48	M	9,71
	RAAFFA0630	2"	15		36	M	11,87
	RAAFFA0900	3"	15		10	M	19,73
	RAAFFA1100	4"	15		20	L	21,96







Drilled Fixed Flange BS 4504 / Bride Collet Perforée BS 4504 / Festflansche BS 4504 / Flangia Fissa Forata BS 4504 / Brida Fija Perforada BS 4504

	Code / Codice	d	PN / PFA	Q.tà min / Min. q.ty	Box	Pack / Imballo	€
A-FNA 	RAAFNA0200	1/2"	15		100	S	4,24
	RAAFNA0250	3/4"	15		60	S	4,69
	RAAFNA0320	1"	15		100	M	6,37
	RAAFNA0400	1 1/4"	15		50	M	7,88
	RAAFNA0500	1 1/2"	15		48	M	9,22
	RAAFNA0630	2"	15		36	M	11,87
	RAAFNA0750	2 1/2"	15		15	M	14,45
	RAAFNA0900	3"	15		10	M	17,00
	RAAFNA1100	4"	15		20	L	21,96

Blank Flange BS 4504 / Bride d'Optutation BS 4504 / Blindflansche BS 4504 / Flangia Cieca Forata BS 4504 / Brida Ciega Perforada BS 4504

	Code / Codice	d	PN / PFA	Q.tà min / Min. q.ty	Box	Pack / Imballo	€
A-FCA 	RAAFCA0630	2"	15		30	M	13,65
	RAAFCA0900	3"	15		30	M	19,56
	RAAFCA1100	4"	15		20	M	27,92

Adaptor Fittings BS / Raccordi d'adaptation BS / Übergangsfittings BS Raccordi di Passaggio BS / Serie de Mixta BS

Elbow 90° Plain/BSP Female Threaded / Coude 90° à Collier BS/Fil F BSP / Winkel 90° / Gomito 90° Incollaggio BS / Fil F BSP / Codo 90° Para Encolar BS/Rosca Hembra BSP							
	Code / Codice	d x Rp (UNI EN 10226)	PN / PFA	Q.tà min / Min. q.ty	Box	Pack / Imballo	€
A-GOC 	RCAGOC020B	1/2" x 1/2"	15		250	S	1,75
	RCAGOC025C	3/4" x 3/4"	15		300	M	2,05
	RCAGOC032D	1" x 1"	15		180	M	2,42
	RCAGOC040E	1 1/4" x 1 1/4"	15		120	M	4,71
	RCAGOC050F	1 1/2" x 1 1/2"	15		120	L	6,51
	RCAGOC063G	2" x 2"	15		60	L	8,93
	RCAGOC090I	3" x 3"	15		25	L	26,86
	RCAGOC110L	4" x 4"	15		13	L	41,44
Tee 90° Plain/BSP Female Threaded Branch / Té 90° à collier/Fil F BSP / T-Stück 90° / Ti 90° Incollaggio BS/Fil F BSP / Te 90° Para Encolar BS/Rosca Hembra BSP H							
	Code / Codice	d x Rp (UNI EN 10226)	PN / PFA	Q.tà min / Min. q.ty	Box	Pack / Imballo	€
A-TIC 	RCATIC020B	1/2" x 1/2"	15		400	M	1,96
	RCATIC025C	3/4" x 3/4"	15		240	M	2,30
	RCATIC032D	1" x 1"	15		100	M	3,07
	RCATIC040E	1 1/4" x 1 1/4"	15		80	M	4,33
	RCATIC050F	1 1/2" x 1 1/2"	15		90	L	8,27
	RCATIC063G	2" x 2"	15		50	L	10,78
	RCATIC090I	3" x 3"	15		20	L	29,16
	RCATIC110L	4" x 4"	15		10	L	47,64
Socket Plain/BSP Female Threaded / Manchon à Collier/Fil F BSP / Klebemuffe BS/IG / Manicotto Incollaggio BS/Fil F BSP / Manguito para Encolar BS/Rosca Hembra BSP							
	Code / Codice	d x Rp (UNI EN 10226)	PN / PFA	Q.tà min / Min. q.ty	Box	Pack / Imballo	€
A-MAC 	RCAMAC020B	1/2" x 1/2"	15		350	S	1,64
	RCAMAC025C	3/4" x 3/4"	15		450	M	1,72
	RCAMAC032D	1" x 1"	15		250	M	1,96
	RCAMAC040E	1 1/4" x 1 1/4"	15		180	M	2,87
	RCAMAC050F	1 1/2" x 1 1/2"	15		120	M	4,33
	RCAMAC063G	2" x 2"	15		75	M	5,85
	RCAMAC090I	3" x 3"	15		45	L	18,36
	RCAMAC110L	4" x 4"	15		30	L	26,89
Adaptor Plain Male Spigot/BSP Female Threaded / Embout à Collier M BS/Fil F BSP / Übergangsnippel IG / Adattatore Incollaggio M BS/Fil F BSP / Adaptador para Encolar Macho BS/Rosca Hembra BSP							
	Code / Codice	d x Rp (UNI EN 10226)	PN / PFA	Q.tà min / Min. q.ty	Box	Pack / Imballo	€
A-AFC 	RCAAFC020B	1/2" x 1/2"	15		350	S	2,30
	RCAAFC025C	3/4" x 3/4"	15		450	M	2,62
	RCAAFC032D	1" x 1"	15		250	M	3,13
	RCAAFC040E	1 1/4" x 1 1/4"	15		180	M	3,40
	RCAAFC050F	1 1/2" x 1 1/2"	15		110	M	4,24
	RCAAFC063G	2" x 2"	15		70	M	7,15
Adaptor Female Plain/BSP Male Threaded / Embout Male BS/Fil F / Übergangsnippel AG / Adattatore Incollaggio F BS/Fil M BSP / Adaptador para Encolar Hembra BS/Rosca Macho BSP							
	Code / Codice	d x Rp (UNI EN 10226)	PN / PFA	Q.tà min / Min. q.ty	Box	Pack / Imballo	€
A-AMC 	RCAAMC020B	1/2" x 1/2"	15		300	S	1,22
	RCAAMC025C	3/4" x 3/4"	15		400	M	1,38
	RCAAMC032D	1" x 1"	15		250	M	1,75
	RCAAMC040E	1 1/4" x 1 1/4"	15		150	M	2,51
	RCAAMC050F	1 1/2" x 1 1/2"	15		120	M	3,59
	RCAAMC063G	2" x 2"	15		45	M	4,45
	RCAAMC090I	3" x 3"	15		45	L	16,22
	RCAAMC110L	4" x 4"	15		30	L	23,18
Reducing Bush Plain/BSP Female Threaded / Reduction Courte à Collier/FIL F / Reduktion kurz IG / Riduzione Corta Incollaggio BS/FIL F BSP / Reducción Corta para Encolar BS/Rosca Hembra BSP							
	Code / Codice	d x Rp (UNI EN 10226)	PN / PFA	Q.tà min / Min. q.ty	Box	Pack / Imballo	€
A-RCC 	RCARCC020A	1/2" x 3/8"	15		1000	S	1,70
	RCARCC025B	3/4" x 1/2"	15		700	S	2,25
	RCARCC032C	1" x 3/4"	15		450	S	3,21

Backnut BSP Female Threaded / Ecrou BSP /FIL F / Überwurfmutter BSP /IG / Ghiera FIL F BSP / Tuerca Roscado Hembra BSP

	Code / Codice	d	PN / PFA	Q.tà min / Min. q.ty	Box	Pack / Imballo	€
A-NUE 	REANUE020B	1/2"			700	S	1,96
	REANUE025C	3/4"			600	S	2,41
	REANUE032D	1"			500	M	3,14
	REANUE040E	1 1/4"			450	M	4,56
	REANUE050F	1 1/2"			300	M	5,31
	REANUE063G	2"			150	M	7,70
	REANUE075H	2 1/2"			100	M	8,67
	REANUE090I	3"			60	M	9,64
	REANUE110L	4"			40	M	11,15

Union Brass BS / Union 3 pièces laiton BS / Verschraubung aus Messing BS / Bocchettone Ottone BS / Unión latón BS

	Code / Codice	d x R (UNI EN 10226)	PN / PFA	Q.tà min / Min. q.ty	Box	Pack / Imballo	€
BNC 	RCABNC020B	20 x 1/2"		10	50	S	11,72
	RCABNC025C	25 x 3/4"		10	30	S	15,01
	RCABNC032D	32 x 1"		10	30	S	19,65
	RCABNC040E	40 x 1 1/4"			20	S	30,85
	RCABNC050F	50 x 1 1/2"			20	S	37,46
	RCABNC063G	63 x 2"			12	S	57,42
	RCABNC075H	75 x 2 1/2"			6	S	126,36
	RCABNC090I	90 x 3"			4	S	143,14

Union Brass BS / Union 3 pièces laiton BS / Verschraubung aus Messing BS / Bocchettone Ottone BS / Unión latón BS

	Code / Codice	d x Rp (UNI EN 10226)	PN / PFA	Q.tà min / Min. q.ty	Box	Pack / Imballo	€
BBC 	RCABBC020B	20 x 1/2"		10	50	S	10,98
	RCABBC025C	25 x 3/4"		10	30	S	14,54
	RCABBC032D	32 x 1"		10	30	S	18,69
	RCABBC040E	40 x 1 1/4"			20	S	29,51
	RCABBC050F	50 x 1 1/2"			20	S	34,95
	RCABBC063G	63 x 2"			12	S	54,83
	RCABBC075H	75 x 2 1/2"			6	S	107,96
	RCABBC090I	90 x 3"			4	S	119,80

**Union Brass/nut PVC-u / Union 3 Pié laiton/ecrou PVC-u / Verschraubung Messing/Überwurfmutter PVC-u
Bocchettone Ottone/ghiera in PVC-u / Unión latón/tuerca PVC-u**

	Code / Codice	d x Rp (UNI EN 10226)	PN / PFA	Q.tà min / Min. q.ty	Box	Pack / Imballo	€
BND Male 	RCABND020B.N	20 x 1/2"		10	150	S	11,72
	RCABND025C.N	25 x 3/4"		10	200	M	15,01
	RCABND032D.N	32 x 1"		10	120	M	19,65
	RCABND040E.N	40 x 1 1/4"			80	M	30,85
	RCABND050F.N	50 x 1 1/2"			60	M	37,46
	RCABND063G.N	63 x 2"			30	M	57,42

**Union Brass/nut PVC-u / Union 3 Pié laiton/ecrou PVC-u / Verschraubung Messing/Überwurfmutter PVC-u
Bocchettone Ottone/ghiera in PVC-u / Unión latón/tuerca PVC-u**

	Code / Codice	d x Rp (UNI EN 10226)	PN / PFA	Q.tà min / Min. q.ty	Box	Pack / Imballo	€
BBD Female 	RCABBD020B.N	20 x 1/2"		10	150	S	10,98
	RCABBD025C.N	25 x 3/4"		10	200	M	14,54
	RCABBD032D.N	32 x 1"		10	120	M	18,69
	RCABBD040E.N	40 x 1 1/4"			80	M	29,51
	RCABBD050F.N	50 x 1 1/2"			60	M	34,95
	RCABBD063G.N	63 x 2"			30	M	54,83

Pipes / Tuyaux / Rohre Tubi / Tubos

Bar Length 6 mt. / Barre Longueur 6 mt. / Stab von 6 mt. / Lunghezza Barra 6 mt. / Longitud Barra 6 mt

	d	Code / Codice	Class C / PN 9 Classe C / PN 9	Code / Codice	Class T / PN 12 Classe T / PN 12	Code / Codice	Class E / PN 15 Classe E / PN 15
	1/2"			TAAT0T0200	On request	TAAT0E0200	On request
	3/4			TAAT0T0250	On request	TAAT0E0250	On request
	1"	TAAT0C0320	On request	TAAT0T0320	On request	TAAT0E0320	On request
	1 1/4"	TAAT0C0400	On request	TAAT0T0400	On request	TAAT0E0400	On request
	1 1/2"	TAAT0C0500	On request	TAAT0T0500	On request	TAAT0E0500	On request
	2"	TAAT0C0630	On request	TAAT0T0630	On request	TAAT0E0630	On request
	2 1/2"	TAAT0C0750	On request				
	3"	TAAT0C0900	On request			TAAT0E0900	On request
	4"	TAAT0C1100	On request			TAAT0E1100	On request
	6"	TAAT0C1600	On request				
	8"	TAAT0C2250	On request				

Temperature and pressure relationship for ABS Pipes

Temperature (°C)	bar (psi)	
	Class C / Classe C	Class E / Classe E
-40	9.0 (130)	15.0 (217)
-20	9.0 (130)	15.0 (217)
0	9.0 (130)	15.0 (217)
20	9.0 (130)	15.0 (217)
30	8.1 (117)	13.5 (195)
40	6.3 (91)	10.5 (152)

Imperial and metric size information

Imperial size		Metric size	
Nominal bore (inches)	Pipe outsider diameter (mm)	Pipe outsider diameter (mm)	Nominal bore (mm)
3/8"	17.1	16	10
1/2"	21.4	20	15
3/4"	26.7	25	20
1"	33.6	32	25
1 1/4"	42.2	40	32
1 1/2"	48.3	50	40
2"	60.3	63	50
2 1/2"	75.2	75	65
3"	88.9	90	80
4"	114.3	110	100
5"	140.2	140	125
6"	168.3	160	150
8"	219.1	225	200

Valves BS / Vannes BS / Kugelhähne BS Valvole BS / Válvulas BS

BS Industrial Ball Valves / Vannes à Boisseau Sphérique pour Industrie BS / Kugelhähne Industrie BS Valvole a Sfera Radiale Industria BS / Válvula de Bola Radial para Encolar BS

Double Union Solvent Cement BS / Union double a coller BS / Radial mit Klebemuffen BS
Valvola a sfera radiale incollaggio BS / Válvula de bola radial para encolar BS

	Code / Codice EPDM	€	Code / Codice FKM	€	d	PN / PFA	Q.tà min Min. q.ty	Box	Pack Imballo
A-BK1A EPDM/FKM 	BAABK1A0160	26,62	BAABK1A016V	34,93	3/8"	16		50	16
	BAABK1A0200	27,19	BAABK1A020V	35,42	1/2"	16		50	16
	BAABK1A0250	33,25	BAABK1A025V	42,43	3/4"	16		20	16
	BAABK1A0320	39,50	BAABK1A032V	51,56	1"	16		20	16
	BAABK1A0400	50,73	BAABK1A040V	66,11	1 1/4"	16		14	16
	BAABK1A0500	64,87	BAABK1A050V	83,98	1 1/2"	16		14	16
	BAABK1A0630	80,40	BAABK1A063V	104,77	2"	16		5	16
	BAABK1A0750	176,32	BAABK1A075V	229,51	2 1/2"	10		1	10
	BAABK1A0900	226,2	BAABK1A090V	288,56	3"	10		1	10
	BAABK1A1100	315,18	BAABK1A110V	391,69	4"	10		1	10

Check Valves BS / Soupapes BS / Kugelrückschlagventile BS Valvole di ritegno BS / Válvula Antiretorno BS

Bs Solvent Cement check Valve / Union double métrique à coller BS / Kugelrückschlagventile BS
Radiale con attacchi incollaggio BS / Válvula de bola antiretorno BS

	Code / Codice EPDM	€	Code / Codice FKM	€	d	PN / PFA	Q.tà min Min. q.ty	Box	Pack Imballo
A-CVA EPDM/FKM 	CAACVA0200	13,40	CAACVA020V	18,82	1/2"	16		60	S
	CAACVA0250	16,08	CAACVA025V	21,79	3/4"	16		40	S
	CAACVA0320	17,21	CAACVA032V	23,64	1"	16		60	M
	CAACVA0400	20,28	CAACVA040V	27,70	1 1/4"	16		40	M
	CAACVA0500	29,45	CAACVA050V	38,23	1 1/2"	16		24	M
	CAACVA0630	39,02	CAACVA063V	50,87	2"	16		13	M

Air release Valve BS / Ventouse BS / Be-und-Entlüftungsventile BS Valvola a Sfogo Aria BS / Válvula Rejilla BS

Double Union BS solvent cement / Union double métrique à coller BS / Radial mit Klebemuffen BS
Radiale con attacchi incollaggio BS / Válvula de purga roscada BS

	Code / Codice EPDM	€	Code / Codice FKM	€	d	PN / PFA	Q.tà min Min. q.ty	Box	Pack Imballo
A-AVA EPDM/FKM 	CAAAVA0200	13,08	CAAAVA020V	17,29	1/2"	16		60	S
	CAAAVA0250	15,68	CAAAVA025V	20,39	3/4"	16		40	S
	CAAAVA0320	16,82	CAAAVA032V	21,79	1"	16		60	M
	CAAAVA0400	18,35	CAAAVA040V	23,84	1 1/4"	16		40	M
	CAAAVA0500	26,99	CAAAVA050V	35,09	1 1/2"	16		24	M
	CAAAVA0630	35,42	CAAAVA063V	46,00	2"	16		13	M

Electrically Actuated Double Union Ball Valve BS / Vanne Boisseau Sphérique à Commande Électrique BS Kugelhahn mit Elektroantrieb BS / Valvola Sfera Radiale Attuatore Elettrico BS / Válvula de Bola con Actuator Eléctrico BS

available 12-24 or 85-240 VAC/VDC / disponible 12-24 ou 85-240 VAC/VDC / verfügbar 12-24 oder 85-240 VAC/VDC
disponible 12-24 o 85-240 VAC/VDC / disponibile 12-24 o 85-240 VAC/VDC

	Code Codice	€	Code Codice	€	d	PN / PFA	Q.tà min Min. q.ty	Box	Pack Imballo
A-EBK1* EPDM	BAAEBK1YA0160	614,08	BAABK1JA0160	614,08	3/8"	16			
	BAAEBK1YA0200	614,08	BAAEBK1JA0200	614,08	1/2"	16			
	BAAEBK1YA0250	620,94	BAAEBK1JA0250	620,94	3/4"	16			
	BAAEBK1YA0320	635,47	BAAEBK1JA0320	635,47	1"	16			
	BAAEBK1YA0400	650,02	BAAEBK1JA0400	650,02	1 1/4"	16			
	BAAEBK1YA0500	719,30	BAAEBK1JA0500	719,30	1 1/2"	16			
	BAAEBK1YA0630	738,95	BAAEBK1JA0630	738,95	2"	16			
	BAAEBK1YA0750	1.139,25	BAAEBK1JA0750	1.139,25	2 1/2"	10			
	BAAEBK1YA0900	1.192,27	BAAEBK1JA0900	1.192,27	3"	10			
	BAAEBK1YA1100	1.317,14	BAAEBK1JA1100	1.317,14	4"	10			



* Available with FKM seals and 12V - 24/240V / Disponibile con guarnizione FKM e 12V - 24/240V

Pneumatically Actuated Double Union Ball Valve BS / Vanne Boisseau Sphérique à Commande Pneumatique BS Kugelhahn mit Pneumatikantrieb Bs / Valvola Sfera Radiale Attuatore Pneumatico Bs / Válvula de Bola con Actuator Neumático BS

Double Acting / Double effect / Doppelwirkend / Doppio Effetto / Doble efecto
Spring return / Simple effect / Einfachwirkend / Semplice effetto / Efecto uno

	Code / Codice A-PBK-D	€	Code / Codice A-PBK-S	€	d	PN / PFA	Q.tà min / Min. q.ty	Box	Pack / Imballo
A-PBK1-D * EPDM	A-PBK1-S * EPDM	BAAPBK1A016D	411,39	BAAPBK1A016S	411,39	3/8"	16		
		BAAPBK1A020D	411,39	BAAPBK1A020S	411,39	1/2"	16		
		BAAPBK1A025D	413,51	BAAPBK1A025S	413,51	3/4"	16		
		BAAPBK1A032D	425,06	BAAPBK1A032S	425,06	1"	16		
		BAAPBK1A040D	431,92	BAAPBK1A040S	431,92	1 1/4"	16		
		BAAPBK1A050D	454,16	BAAPBK1A050S	454,16	1 1/2"	16		
		BAAPBK1A063D	473,82	BAAPBK1A063S	473,82	2"	16		
		BAAPBK1A075D	746,66	BAAPBK1A075S	746,66	2 1/2"	10		
		BAAPBK1A090D	1.003,57	BAAPBK1A090S	1.003,57	3"	10		
		BAAPBK1A110D	1.217,06	BAAPBK1A110S	1.217,06	4"	10		



Double Acting/Doppio Effetto / Spring return/Semplice effetto

* Available with FPM seals / Disponibile con guarnizione FPM

ABS Red Pipes & Fittings
Tuyaux et Raccords en ABS Rouge
Rote Rohre und Klebefittings aus ABS
Raccordi e Tubi in ABS Rosso
Tubos y Accesorios Rojos en ABS



Pipes & Fittings / Tuyaux et Raccords / Rohre und Klebefittings Raccordi e Tubi / Tubos y Accesorios

Bend 90° / Courbe 90° / Bogen 90° / Curva 90° / Curva 90°

	Code / Codice	d	PN / PFA	Box	Pack / Imballo	€
CUA - CUD 	RAACUA025R	¾"	15	150	M	6,64
	RDACUD0250R	25	15	150	M	5,66

Elbow 45° BS / Coude 45° BS / Winkel 45° BS / Gomito 45° BS / Codo 45° BS

	Code / Codice	d	PN / PFA	Box	Pack / Imballo	€
GYA - GYD 	RAAGYA025R	¾"	15	400	M	1,84
	RDAGYD0250R	25	15	400	M	2,19

Socket BS / Manchon BS / Muffe BS / Manicotto BS / Manguito BS

	Code / Codice	d	PN / PFA	Box	Pack / Imballo	€
MAA - MAD 	RAAMAA025R	¾"	15	400	M	0,92
	RDAMAD0250R	25	15	400	M	0,99

Tee 90° BS / Té 90° BS / T-Stück 90° BS / Ti a 90° BS / Te 90° BS

	Code / Codice	d	PN / PFA	Box	Pack / Imballo	€
TIA - TID 	RAATIA025R	¾"	15	200	M	1,38
	RDATID0250R	25	15	200	M	0,99

Cap BS / Bouchon BS / Kappe BS / Calotta BS / Tapón BS

	Code / Codice	d	PN / PFA	Box	Pack / Imballo	€
CAA - CAD 	RAACAA025R	¾"	15	350	S	0,99
	RDACAD0250R	25	15	350	S	1,09

Union with O-ring BS / Union 3 Pièces BS / Verschraubungen 3 Stk. BS / Bocchettone BS / Unión BS

	Code / Codice	d	PN / PFA	Box	Pack / Imballo	€
BOA EPDM BOD EPDM 	RAABOA025R	¾"	15	200	M	4,01
	RDABOD0250R	25	15	200	M	4,64

Plug / Bouchon / Stopfen / Tappo / Tapón

	Code / Codice	d	PN / PFA	Box	Pack / Imballo	€
REA 	REANIE010R.T	25	15			2,41

Pipeclips / Clip avec Bloquage / Rohrhalter / Portatubi / Abrazadera para tubería cerrada

	Code / Codice	d	PN / PFA	Box	Pack / Imballo	€
RHP 	RHPPTH025R	25 - ¾"	15			0,88

ABS Red Pipes BS / Tuyaux ABS Rouge BS / ABS Rote Rohre BS / Tubi ABS Rosso BS / Tubos ABS Rojos BS

	Code / Codice	d	PN / PFA	Box	Pack / Imballo	€
TAAT - TDAT 	TAAT16025R	¾"	15			On request
	TDAT160250R	25	15			On request

PPH Fittings and Valves
Raccords et Vannes en PPH
Fittings und Kugelhähne aus PPH
Raccordi e Valvole in PPH
Tubos y Accesorios en PPH



Fittings for Socket Fusion Jointing / Raccordi per Soudure dans l'Emboîture

Muffenschweissfittings / Raccordi per Saldatura nel Bicchiere / Accesorios para Soldadura en el Vaso

90° Elbow / Coude 90° / Winkel 90° / Gomito a 90° / Codo 90°

	Code / Codice	d	PN / PFA	Q.tà min / Q.ty until	Box	Pack / Imballo	€
GOH 	RHPGOH0200	20	10		250	S	2,82
	RHPGOH0250	25	10		300	M	3,17
	RHPGOH0320	32	10		180	M	3,74
	RHPGOH0400	40	10		120	L	4,73
	RHPGOH0500	50	10		120	L	8,82
	RHPGOH0630	63	10		60	L	10,94
	RHPGOH0750	75	10		40	L	52,71
	RHPGOH0900	90	10		25	L	64,74
RHPGOH1100	110	10		14	L	96,94	

45° Elbow / Coude 45° / Winkel 45° / Gomito a 45° / Codo 45°

	Code / Codice	d	PN / PFA	Q.tà min / Q.ty until	Box	Pack / Imballo	€
GYH 	RHPGYH0200	20	10		300	S	3,74
	RHPGYH0250	25	10		400	M	4,10
	RHPGYH0320	32	10		200	M	4,73
	RHPGYH0400	40	10		150	M	5,86
	RHPGYH0500	50	10		150	L	8,47
	RHPGYH0630	63	10		90	L	10,59
	RHPGYH0750	75	10		50	L	40,61
	RHPGYH0900	90	10		30	L	60,44
	RHPGYH1100	110	10		16	L	89,26

90° Tee / Té 90° / T-Stück 90° / Ti a 90° / Te 90°

	Code / Codice	d	PN / PFA	Q.tà min / Q.ty until	Box	Pack / Imballo	€
TIH 	RHPTIH0200	20	10		400	M	3,17
	RHPTIH0250	25	10		200	M	3,45
	RHPTIH0320	32	10		100	M	3,81
	RHPTIH0400	40	10		70	M	4,66
	RHPTIH0500	50	10		90	L	8,54
	RHPTIH0630	63	10		50	L	11,70
	RHPTIH0750	75	10		32	L	55,73
	RHPTIH0900	90	10		20	L	86,42
	RHPTIH1100	110	10		10	L	115,54

Socket / Manchon / Muffe / Manicotto / Manguito

	Code / Codice	d	PN / PFA	Q.tà min / Q.ty until	Box	Pack / Imballo	€
MAH 	RHPMAH0200	20	10		350	S	1,69
	RHPMAH0250	25	10		400	M	1,83
	RHPMAH0320	32	10		250	M	2,47
	RHPMAH0400	40	10		180	M	3,02
	RHPMAH0500	50	10		200	L	5,44
	RHPMAH0630	63	10		100	L	8,18
	RHPMAH0750	75	10		80	L	21,92
	RHPMAH0900	90	10		45	L	31,02
	RHPMAH1100	110	10		27	L	53,24

Concentric Reducer / Réduction concentrique / Zentrische Reduktion / Riduzione Concentrica / Reducción Concéntrica

	Code / Codice	d	PN / PFA	Q.tà min / Q.ty until	Box	Pack / Imballo	€
RLH 	RHPRLH025B	25 x 20	10		300	S	5,13
	RHPRLH032B	32 x 20	10		170	S	5,54
	RHPRLH032C	32 x 25	10		170	S	6,02
	RHPRLH040C	40 x 25	10		220	M	7,39
	RHPRLH040D	40 x 32	10		200	M	7,39
	RHPRLH050D	50 x 32	10		130	M	9,12
	RHPRLH050E	50 x 40	10		120	M	9,12
	RHPRLH063E	63 x 40	10		80	M	10,43
	RHPRLH063F	63 x 50	10		80	M	11,14
	RHPRLH075G	75 x 63	10		80	M	19,12
	RHPRLH090G	90 x 63	10		36	M	26,38
	RHPRLH090H	90 x 75	10		36	M	26,38
	RHPRLH110G	110 x 63	10		36	M	35,97
RHPRLH110I	110 x 90	10		42	L	35,97	

Cap / Bouchon / Kappe / Calotta / Tapón

	Code / Codice	d	PN / PFA	Q.tà min / Q.ty until	Box	Pack / Imballo	€
CAH 	RHPCAH0200	20	10		500	S	2,11
	RHPCAH0250	25	10		300	S	2,26
	RHPCAH0320	32	10		400	M	2,68
	RHPCAH0400	40	10		250	M	3,67
	RHPCAH0500	50	10		180	M	4,94
	RHPCAH0630	63	10		100	M	6,61
	RHPCAH0750	75	10		60	L	27,15
	RHPCAH0900	90	10		65	L	38,29
	RHPCAH1100	110	10		40	L	51,92

Stub Serrated / Collet Strié / Bundbuchen gerillt / Collare per flange rigato / Manguito portabridas

	Code / Codice	d	PN / PFA	Q.tà min / Q.ty until	Box	Pack / Imballo	€
QRH 	RHPQRH0200	20	10		500	S	2,04
	RHPQRH0250	25	10		300	S	2,19
	RHPQRH0320	32	10		200	S	2,47
	RHPQRH0400	40	10		200	M	2,97
	RHPQRH0500	50	10		180	M	3,39
	RHPQRH0630	63	10		90	M	4,58
	RHPQRH0750	75	10		120	L	17,38
	RHPQRH0900	90	10		70	L	26,80
	RHPQRH1100	110	10		40	L	39,83

Union with O-Ring / Union 3 pièces / Verschraubungen 3 Stk. / Bocchettone con O-Ring / Unión O-Ring

	Code / Codice	d	PN / PFA	Q.tà min / Q.ty until	Box	Pack / Imballo	€
BOH* 	RHPBOH0200	20	10		150	S	10,86
	RHPBOH0250	25	10		200	M	11,70
	RHPBOH0320	32	10		120	M	14,10
	RHPBOH0400	40	10		80	M	19,03
	RHPBOH0500	50	10		50	M	26,58
	RHPBOH0630	63	10		30	M	37,85

Valves / Vannes / Kugelhähne Valvole / Válvulas

PP-H Industrial Ball Valve / Vanne à Boisseau Sphérique en PP-H pour Industrie / PP-H Industrie Kugelhähne Valvola a Sfera in PP-H per Industria / Válvula de Bola en PP-H para Industria

Double union, metric Socket Fusion / Double union pour soudure dans l'emboîture / Radial für Muffenschweiss
Radiale con attacchi per saldatura nel bicchiere / Válvula de Bola, Modelo Industrial para Soldadura en el Vaso

	Code / Codice EPDM	€	Code / Codice FKM	€	d	PN / PFA	Q.tà min Min. q.ty	Box	Pack Imballo
BKH EPDM/FKM 	BHPBK1H0200	46,56	BHPBK1H020V	49,98	20	10		1	
	BHPBK1H0250	55,00	BHPBK1H025V	59,56	25	10		1	
	BHPBK1H0320	67,34	BHPBK1H032V	73,26	32	10		1	
	BHPBK1H0400	83,21	BHPBK1H040V	90,37	40	10		1	
	BHPBK1H0500	107,19	BHPBK1H050V	116,40	50	10		1	
	BHPBK1H0630	128,36	BHPBK1H063V	139,68	63	10		1	

Double union, BSP Threaded / Union double à Manchons Taraudés BSP / BSP Radial mit Gewindemuffen
Radiale con Attacchi Filettati BSP / Válvula de bola Roscada BSP

	Code / Codice EPDM	€	Code / Codice FKM	€	Rp (UNI EN 10226)	PN / PFA	Q.tà min Min. q.ty	Box	Pack Imballo
BKEH EPDM/FKM 	BHPBK1EH020B	51,48	BHPBK1EH020V	55,70	1/2"	10		1	
	BHPBK1EH025C	61,36	BHPBK1EH025V	67,28	3/4"	10		1	
	BHPBK1EH032D	75,47	BHPBK1EH032V	81,42	1"	10		1	
	BHPBK1EH040E	93,08	BHPBK1EH040V	99,63	1 1/4"	10		1	
	BHPBK1EH050F	119,88	BHPBK1EH050V	129,36	1 1/2"	10		1	
	BHPBK1EH063G	143,86	BHPBK1EH063V	155,33	2"	10		1	

PP-H Check Valve / Soupape en PP-H / PP-H Rückschlagventil Valvola di non ritorno in PP-H / Válvula Antiretorno en PP-H



Double union, metric Socket Fusion / Double union pour soudure dans l'emboîture / Radial für Muffenschweiss
Radiale con attacchi per saldatura nel bicchiere / Válvula de bola, modelo industrial para soldadura en el vaso

	Code / Codice EPDM	€	Code / Codice FKM	€	d	PN / PFA	Q.tà min Min. q.ty	Box	Pack Imballo
CVH EPDM/FKM 	CHPCVH0200	34,22	CHPCVH020V	36,96	20	10		1	
	CHPCVH0250	41,09	CHPCVH025V	44,36	25	10		1	
	CHPCVH0320	52,05	CHPCVH032V	56,20	32	10		1	
	CHPCVH0400	64,35	CHPCVH040V	69,49	40	10		1	
	CHPCVH0500	82,15	CHPCVH050V	88,72	50	10		1	
	CHPCVH0630	99,28	CHPCVH063V	107,22	63	10		1	

Double union, BSP threaded / Double union à manchons taraudés / Radial mit Gewindemuffen
Radiale con attacchi filettati / Válvula de bola roscada BSP

	Code / Codice EPDM	€	Code / Codice FKM	€	Rp (UNI EN 10226)	PN / PFA	Q.tà min Min. q.ty	Box	Pack Imballo
CVEH EPDM/FKM 	CHPCVEH020B	35,24	CHPCVEH020V	38,06	1/2"	10		1	
	CHPCVEH025C	42,31	CHPCVEH025V	45,70	3/4"	10		1	
	CHPCVEH032D	53,60	CHPCVEH032V	57,90	1"	10		1	
	CHPCVEH040E	66,29	CHPCVEH040V	71,60	1 1/4"	10		1	
	CHPCVEH050F	84,61	CHPCVEH050V	91,39	1 1/2"	10		1	
	CHPCVEH063G	102,26	CHPCVEH063V	110,43	2"	10		1	

High Performance Butterfly Valves / Vannes à Papillon à Hautes Performance / Hochleistungsabsperklappen / Valvole a Farfalla Alte Prestazioni / Válvulas a Mariposa a Alto Rendimiento

		PROFLOW T Series - Hand operated Industry butterfly valve in PPH with EPDM seals / PROFLOW T Série - Vanne à papillon avec poignée et joints en EPDM / PROFLOW T Reihe - PPH Handbediente Industrie Absperrklappe mit EPDM Dichtungen / PROFLOW Serie T - Valvola a farfalla Industria in PPH con maniglia e guarnizioni in EPDM / PROFLOW T Serie - Válvula de mariposa con maneta y juntos en EPDM								
		Code / Codice	Description / Descrizione	Ø	DN	PFA	Gua/Seal	O'ring	Asta/Stem	€
PFT EPDM		FHPPFT0750	ProFlow Serie T PPH	75	65	10	EPDM	EPDM	SS AISI 316	289,60
		FHPPFT0900	ProFlow Serie T PPH	90	80	10	EPDM	EPDM	SS AISI 316	322,48
		FHPPFT1100	ProFlow Serie T PPH	110	100	10	EPDM	EPDM	SS AISI 316	398,16
		FHPPFT1400*	ProFlow Serie T PPH	125-140	125	10	EPDM	EPDM	SS AISI 316	468,78
		FHPPFT1600*	ProFlow Serie T PPH	160	150	10	EPDM	EPDM	SS AISI 316	556,66
		FHPPFT2250*	ProFlow Serie T PPH	200-225	200	6	EPDM	EPDM	SS AISI 316	722,13
Optional a richiesta / Optional on request: Volantino/Handwheel – flangiata / flanged										
		PROFLOW T Series - Hand operated Industry butterfly valve in PPH with FKM seals / PROFLOW T Série - Vanne à papillon avec poignée et joints en FKM / PROFLOW T Reihe - PPH Handbediente Industrie Absperrklappe mit FKM Dichtungen / PROFLOW Serie T - Valvola a farfalla Industria in PPH con maniglia e guarnizioni in FKM / PROFLOW T Serie - Válvula de mariposa con maneta y juntos en FKM								
		Code / Codice	Description / Descrizione	Ø	DN	PFA	Gua/Seal	O'ring	Asta/Stem	€
PFT FKM		FHPPFT075V	ProFlow Serie T PPH	75	65	10	FKM	FKM	SS AISI 316	398,80
		FHPPFT090V	ProFlow Serie T PPH	90	80	10	FKM	FKM	SS AISI 316	476,38
		FHPPFT110V	ProFlow Serie T PPH	110	100	10	FKM	FKM	SS AISI 316	558,56
		FHPPFT140V*	ProFlow Serie T PPH	125-140	125	10	FKM	FKM	SS AISI 316	600,34
		FHPPFT160V*	ProFlow Serie T PPH	160	150	10	FKM	FKM	SS AISI 316	741,52
		FHPPFT225V*	ProFlow Serie T PPH	200-225	200	6	FKM	FKM	SS AISI 316	922,48
Optional a richiesta / Optional on request: Volantino/Handwheel – flangiata / flanged										

* Available later this year / * Disponibili in corso dell'anno

Pipes / Tuyaux / Rohre Tubi / Tubos

Pressure Pipes / Tubes a Pression / Druckrohre / Tubi a Pressione / Tubos a Presión						
Code / Codice	d	PN / PFA	Q.tà min / Min. q.ty	Box	Pack / Imballo	€
THPT100200	20	10	5 mt			On request
THPT100250	25	10	5 mt			On request
THPT100320	32	10	5 mt			On request
THPT100400	40	10	5 mt			On request
THPT100500	50	10	5 mt			On request
THPT100630	63	10	5 mt			On request
THPT100750	75	10	5 mt			On request
THPT100900	90	10	5 mt			On request
THPT101100	110	10	5 mt			On request

PE 100 Fittings / Raccords en PE 100
Fittings aus PE 100
Raccordi in PE 100 / Accesorios en PE 100



E-Fusion Fittings / Raccords / Fittings

Raccordi Elettrosaldabili / Accesorios Electrosoldables

Socket / Manchon / Muffe / Manicotto / Manguito										
	Code / Codice	d	PFA	Box	€	Code / Codice	d	PFA	Box	€
MANICOTTO 	REPMAD0200	20	16	80	5,85	REPMAD1400	140	16	6	42,32
	REPMAD0250	25	16	80	6,33	REPMAD1600	160	16	4	45,02
	REPMAD0320	32	16	75	6,48	REPMAD1800	180	16	4	54,94
	REPMAD0400	40	16	90	6,82	REPMAD2000	200	16	4	64,02
	REPMAD0500	50	16	70	9,63	REPMAD2250	225	16	2	99,91
	REPMAD0630	63	16	25	10,60	REPMAD2500	250	16	2	160,10
	REPMAD0750	75	16	45	15,36	REPMAD2800	280	16	1	220,19
	REPMAD0900	90	16	30	17,20	REPMAD3150	315	16	1	260,23
	REPMAD1100	110	16	18	20,71	REPMAD3550	355	16	1	427,52
	REPMAD1250	125	16	12	29,75	REPMAD4000	400	16	1	520,24
Elbow 90° / Coude 90° / Winkel 90° / Gomito 90° / Codo 90°										
	Code / Codice	d	PFA	Box	€	Code / Codice	d	PFA	Box	€
GOMITO 90° 	REPGOD0200	20	16	100	15,57	REPGOD0750	75	16	25	43,04
	REPGOD0250	25	16	100	16,19	REPGOD0900	90	16	15	44,57
	REPGOD0320	32	16	80	17,04	REPGOD1100	110	16	6	64,86
	REPGOD0400	40	16	55	18,33	REPGOD1250	125	16	6	119,83
	REPGOD0500	50	16	55	24,44	REPGOD1600	160	16	2	150,01
	REPGOD0630	63	16	25	27,51	REPGOD1800	180	16	2	170,62
	Elbow 45° / Coude 45° / Winkel 45° / Gomito 45° / Codo 45°									
	Code / Codice	d	PFA	Box	€	Code / Codice	d	PFA	Box	€
GOMITO 45° 	REPGYD0320	32	16	100	16,06	REPGYD0900	90	16	18	47,27
	REPGYD0400	40	16	70	19,42	REPGYD1100	110	16	10	66,15
	REPGYD0500	50	16	50	25,31	REPGYD1250	125	16	6	113,89
	REPGYD0630	63	16	30	30,18	REPGYD1600	160	16	2	144,44
	REPGYD0750	75	16	20	41,53	REPGYD1800	180	16	2	170,62
	Reduction / Reduction / Reduktion / Riduzione / Reducción									
	Code / Codice	d	PFA	Box	€	Code / Codice	d	PFA	Box	€
RIDUZIONE E/F 	REPRLD025B	25 x 20	16	75	10,93	REPRLD063F	63 x 50	16	60	21,85
	REPRLD032B	32 x 20	16	75	10,93	REPRLD075G	75 x 63	16	28	39,63
	REPRLD032C	32 x 25	16	75	11,90	REPRLD090G	90 x 63	16	35	39,72
	REPRLD040D	40 x 32	16	100	16,98	REPRLD110G	110 x 63	16	18	66,64
	REPRLD050D	50 x 32	16	80	19,98	REPRLD110I	110 x 90	16	20	46,77
	REPRLD050E	50 x 40	16	80	21,04	REPRLD125I	125 x 90	16	12	86,54
	REPRLD063D	63 x 32	16	60	20,71	REPRLD160L	160 x 110	16	4	109,76
	REPRLD063E	63 x 40	16	60	21,03	REPRLD180M	180 x 125	16	4	120,01
Tee 90° / Tè 90° / T-Stuck 90° / Ti a 90° / Ti 90°										
	Code / Codice	d	PFA	Box	€	Code / Codice	d	PFA	Box	€
TI a 90° 	REPTID0200	20	16	75	15,73	REPTID0750	75	16	12	45,75
	REPTID0250	25	16	75	16,87	REPTID0900	90	16	7	45,86
	REPTID0320	32	16	50	17,52	REPTID1100	110	16	6	69,16
	REPTID0400	40	16	18	21,96	REPTID1250	125	16	4	93,96
	REPTID0500	50	16	25	24,92	REPTID1600	160	16	2	150,28
	REPTID0630	63	16	20	27,81	REPTID1800	180	16	2	195,24
	Cap / Bouchon / Kappe / Calotta / Tapón									
	Code / Codice	d	PFA	Box	€	Code / Codice	d	PFA	Box	€
CALOTTA 	REPCAD0200	20	16	80	8,64	REPCAD1100	110	16	18	45,21
	REPCAD0250	25	16	80	8,91	REPCAD1250	125	16	10	65,84
	REPCAD0320	32	16	75	11,22	REPCAD1400	140	16	6	105,64
	REPCAD0400	40	16	90	13,03	REPCAD1600	160	16	4	88,25
	REPCAD0500	50	16	70	16,61	REPCAD1800	180	16	4	120,05
	REPCAD0630	63	16	25	18,93	REPCAD2000	200	16	4	167,62
	REPCAD0750	75	16	45	31,78	REPCAD2250	225	16	2	227,48
	REPCAD0900	90	16	30	36,07	REPCAD2500	250	16	2	245,23

Clamp Saddles / Colliers de Prise en Charge / Anbohrschellen Collari di Presa in Carico / Collarín de Toma en Carga

Clamp Saddles / Colliers de Prise en Charge / Anbohrschellen / Collari di presa in Carico / Collarín de Toma en Carga

	Code Codice	d	PN / PFA	Box	€	Code Codice	d	PN / PFA	Box	€
COLLARE di Presa in Carico	REPQRD063B	63 x 20	16	12	61,98	REPQRD125E	125 x 40	16	10	105,98
	REPQRD063C	63 x 25	16	12	61,98	REPQRD125F	125 x 50	16	10	105,98
	REPQRD063D	63 x 32	16	12	61,98	REPQRD125G	125 x 63	16	5	105,98
	REPQRD063E	63 x 40	16	5	92,46	REPQRD160B	160 x 20	16	8	81,11
	REPQRD063F	63 x 50	16	5	92,46	REPQRD160C	160 x 25	16	8	81,11
	REPQRD063G	63 x 63	16	5	97,61	REPQRD160D	160 x 32	16	8	81,11
	REPQRD075B	75 x 20	16	12	63,38	REPQRD160E	160 x 40	16	10	122,82
	REPQRD075C	75 x 25	16	12	63,38	REPQRD160F	160 x 50	16	10	122,82
	REPQRD075D	75 x 32	16	12	63,38	REPQRD160G	160 x 63	16	5	122,82
	REPQRD075E	75 x 40	16	10	101,01	REPQRD180B	180 x 20	16	8	89,74
	REPQRD075F	75 x 50	16	10	101,01	REPQRD180C	180 x 25	16	8	89,74
	REPQRD075G	75 x 63	16	5	101,01	REPQRD180D	180 x 32	16	8	89,74
	REPQRD090B	90 x 20	16	10	61,98	REPQRD180E	180 x 40	16	10	123,73
	REPQRD090C	90 x 25	16	10	61,98	REPQRD180F	180 x 50	16	10	123,73
	REPQRD090D	90 x 32	16	10	61,98	REPQRD180G	180 x 63	16	5	123,73
	REPQRD090E	90 x 40	16	10	101,01	REPQRD200B	200 x 20	16	5	139,58
	REPQRD090F	90 x 50	16	10	101,01	REPQRD200C	200 x 25	16	5	139,58
	REPQRD090G	90 x 63	16	5	101,01	REPQRD200D	200 x 32	16	5	139,58
	REPQRD110B	110 x 20	16	10	62,94	REPQRD200E	200 x 40	16	5	143,47
	REPQRD110C	110 x 25	16	10	62,94	REPQRD200F	200 x 50	16	5	143,47
	REPQRD110D	110 x 32	16	10	62,94	REPQRD200G	200 x 63	16	5	143,47
	REPQRD110E	110 x 40	16	10	104,26	REPQRD225B	225 x 20	16	5	144,66
	REPQRD110F	110 x 50	16	10	104,26	REPQRD225C	225 x 25	16	5	144,66
	REPQRD110G	110 x 63	16	5	104,26	REPQRD225D	225 x 32	16	5	144,66
	REPQRD125B	125 x 20	16	8	65,44	REPQRD225E	225 x 40	16	5	153,22
	REPQRD125C	125 x 25	16	8	65,44	REPQRD225F	225 x 50	16	5	153,22
	REPQRD125D	125 x 32	16	8	65,44	REPQRD225G	225 x 63	16	5	153,22

Simple Clamp Saddle / Collier de Prise Simple / Eingängige Anbohrschellen / Collare di Presa Semplice / Collarín de Toma Simple

	Code Codice	d	PN / PFA	Box	€	Code Codice	d	PN / PFA	Box	€
COLLARE	REPQRS063C	63 x 25	16	15	36,07	REPQRS125E	125 x 40	16	10	46,19
	REPQRS063D	63 x 32	16	15	36,07	REPQRS125F	125 x 50	16	10	46,19
	REPQRS063E	63 x 40	16	10	36,07	REPQRS125G	125 x 63	16	10	46,19
	REPQRS063F	63 x 50	16	10	36,07	REPQRS160E	160 x 40	16	10	66,52
	REPQRS063G	63 x 63	16	10	36,07	REPQRS160F	160 x 50	16	10	66,52
	REPQRS075E	75 x 40	16	10	44,38	REPQRS160G	160 x 63	16	10	66,52
	REPQRS075F	75 x 50	16	10	44,38	REPQRS180E	180 x 40	16	10	80,36
	REPQRS075G	75 x 63	16	10	44,38	REPQRS180F	180 x 50	16	10	80,36
	REPQRS090D	90 x 32	16	10	42,68	REPQRS180G	180 x 63	16	10	80,36
	REPQRS090E	90 x 40	16	10	42,68	REPQRS200E	200 x 40	16	10	88,00
	REPQRS090F	90 x 50	16	10	42,68	REPQRS200F	200 x 50	16	10	88,00
	REPQRS090G	90 x 63	16	10	42,68	REPQRS200G	200 x 63	16	10	88,00
	REPQRS110E	110 x 40	16	10	44,24	REPQRS225E	225 x 40	16	10	95,68
	REPQRS110F	110 x 50	16	10	44,24	REPQRS225F	225 x 50	16	10	95,68
	REPQRS110G	110 x 63	16	10	44,24	REPQRS225G	225 x 63	16	10	95,68

Butt Welding Fittings with Elongated Spigots / Raccords avec Extrémités Allongées pour Soudure Boût-a-Boût / Fittings mit langen Schweissenden / Raccordi Testa a Testa con Estremità Allungate / Accesorios con Extremidades Alargadas para Soldadura

Long Cap / Bouchon Longue / Lang Kappe / Calotta / Tapón Largo

	Code / Codice	d	PN / PFA	Q.tà min / Min. q.ty	Box	Pack / Imballo	€
CALOTTA 	REPCAL0630	63	16		1		15,80
	REPCAL0750	75	16		1		24,63
	REPCAL0900	90	16		1		34,86
	REPCAL1100	110	16		1		45,65
	REPCAL1250	125	16		1		54,94
	REPCAL1400	140	16		1		82,59
	REPCAL1600	160	16		1		88,25
	REPCAL1800	180	16		1		136,27
	REPCAL2000	200	16		1		141,36
	REPCAL2250	225	16		1		183,40
	REPCAL2500	250	16		1		220,17
	REPCAL2800	280	16		1		390,93
REPCAL3150	315	16		1		452,07	

Stub Flanges / Collet Striè / Bundbuchsen gerillt / Collare per Flange / Manguito Portabridas

	Code / Codice	d	PN / PFA	Q.tà min / Min. q.ty	Box	Pack / Imballo	€
COLLARE 	REPQRL0320	32	16		1		9,00
	REPQRL0400	40	16		1		9,94
	REPQRL0500	50	16		1		11,35
	REPQRL0630	63	16		1		12,99
	REPQRL0750	75	16		1		15,84
	REPQRL0900	90	16		1		19,30
	REPQRL1100	110	16		1		23,88
	REPQRL1250	125	16		1		29,05
	REPQRL1400	140	16		1		38,07
	REPQRL1600	160	16		1		43,10
	REPQRL1800	180	16		1		70,41
	REPQRL2000	200	16		1		82,10
	REPQRL2250	225	16		1		106,43
	REPQRL2500	250	16		1		140,35
	REPQRL2800	280	16		1		227,45
REPQRL3150	315	16		1		261,27	

Zinc-Plated S/S Loose Flange PN16 / Bride En Acier Zinc PN16 / S/S Verzinkte Losflansche PN16 / Flangia in Acciaio Zincata PN16 / Brida en Acero Cincado PN16

	Code / Codice	d	DN	PN / PFA	Q.tà min / Min. q.ty	Box	Pack / Imballo	€
FLANGIA Libera Acciaio 	REPFLZ0200	20	15				1	14,23
	REPFLZ0250	25	20				1	14,67
	REPFLZ0320	32	25				1	15,20
	REPFLZ0400	40	32				1	16,35
	REPFLZ0500	50	40				1	17,95
	REPFLZ0630	63	50				1	20,67
	REPFLZ0750	75	65				1	26,96
	REPFLZ0900	90	80				1	30,53
	REPFLZ1100	110	100				1	37,60
	REPFLZ1250	125	100				1	37,60
	REPFLZ1250M	125	125				1	37,60
	REPFLZ1400	140	125				1	55,48
	REPFLZ1600	160	150				1	66,38
	REPFLZ1800	180	150				1	66,38
	REPFLZ2000	200	200				1	94,83
	REPFLZ2250	225	200				1	94,83
	REPFLZ2500	250	250				1	133,48
	REPFLZ2800	280	250				1	216,48
	REPFLZ3150	315	300				1	216,48

Epoxy Coated Aluminium Loose Flange PN 16 / Bride Libre Aluminium Verni Epoxy PN 16 / Aluminium Epoxidharz Losflansche PN 16
Flangia in Alluminio Verniciata Epossidica PN 16 / Brida Libre en Aluminio Barnizado Epoxidico PN 16

	Code / Codice	d	DN	PN / PFA	Q.tà min / Min. q.ty	Box	Pack / Imballo	€
FLANGIA Libera Alluminio Verniciata 	REPFLR0250	25	20			1		16,43
	REPFLR0320	32	25			1		17,66
	REPFLR0400	40	32			1		22,33
	REPFLR0500	50	40			1		25,70
	REPFLR0630	63	50			1		29,14
	REPFLR0750	75	65			1		33,01
	REPFLR0900	90	80			1		40,64
	REPFLR1100	110	100			1		40,64
	REPFLR1250	125	100			1		40,64
	REPFLR1400	140	125			1		59,97
	REPFLR1600	160	150			1		71,77
	REPFLR1800	180	150			1		71,77
	REPFLR2000	200	200			1		102,53
	REPFLR2250	225	200			1		102,53
	REPFLR2500	250	250			1		144,30
REPFLR2800	280	250			1		144,30	
REPFLR3150	315	300			1		202,03	

Compression Fittings and Clamp Saddles Raccords à Pression et Colliers de Prise Klemmverbinder und Anbohrschellen Giunti a Compressione e Prese a Staffa Accesorios de Compresión y Collarines de Fijación



Saddles







Range 3



Range 4

Compression Fittings / Raccords à Pression / Klemmverbinder Giunti a Compressione / Accesorios de Compresión

Coupling / Manchon / Muffe / Manicotto / Manguito							
	Code / Codice	d	PN / PFA	Q.tà min / Min. q.ty	Box	Pack / Imballo	€
310 	GDP3100200	20	16	20	200		2,70
	GDP3100250	25	16	10	120		3,55
	GDP3100320	32	16	10	60		4,51
	GDP3100400	40	16		40		7,40
	GDP3100500	50	16		30		9,96
	GDP3100630	63	16		15		13,82
	GDP3100750	75	10		14		43,57
	GDP3100900	90	10		9		53,77
	GDP3101100	110	10		5		113,18
Reduced Coupling / Manchon Réduit / Reduzierte Muffe / Manicotto ridotto / Manguito Reducido							
	Code / Codice	d	PN / PFA	Q.tà min / Min. q.ty	Box	Pack / Imballo	€
311 	GDP311025B	25 x 20	16	20	120		3,03
	GDP311032B	32 x 20	16	10	100		4,26
	GDP311032C	32 x 25	16	10	80		4,26
	GDP311040C	40 x 25	16		60		6,98
	GDP311040D	40 x 32	16		45		6,98
	GDP311050C	50 x 25	16		30		9,08
	GDP311050D	50 x 32	16		30		9,08
	GDP311050E	50 x 40	16		30		9,08
	GDP311063D	63 x 32	16		20		12,69
	GDP311063E	63 x 40	16		20		12,69
	GDP311063F	63 x 50	16		20		12,69
	GDP311075G	75 x 63	10		16		45,73
	GDP311090G	90 x 63	10		12		51,50
	GDP311090H	90 x 75	10		12		51,50
	GDP311110H	110 x 75	10		6		107,53
	GDP311110I	110 x 90	10		6		107,53
	End Cap / Bouchon de Fermeture / Endkappe / Tappo Terminale / Tapón Terminal						
	Code / Codice	d	PN / PFA	Q.tà min / Min. q.ty	Box	Pack / Imballo	€
312 	GDP3120200	20	16	20	360		1,98
	GDP3120250	25	16	10	250		2,16
	GDP3120320	32	16	10	150		2,70
	GDP3120400	40	16		60		4,32
	GDP3120500	50	16		40		6,30
	GDP3120630	63	16		25		8,59
	GDP3120750	75	10		25		35,74
	GDP3120900	90	10		16		40,27
	GDP3121100	110	10		8		85,28
Male Adaptor / Raccord Mâle / Anschlußverschraubungen AG / Raccordo Maschio / Accesorio Macho							
	Code / Codice	d x R (UNI EN 10226)	PN / PFA	Q.tà min / Min. q.ty	Box	Pack / Imballo	€
320 	GGP320020B	20 x 1/2"	16	20	360		1,64
	GGP320020C	20 x 3/4"	16	20	360		1,64
	GGP320025B	25 x 1/2"	16	10	250		1,94
	GGP320025C	25 x 3/4"	16	10	250		1,94
	GGP320025D	25 x 1"	16	10	250		1,94
	GGP320032C	32 x 3/4"	16	10	120		2,39
	GGP320032D	32 x 1"	16	10	120		2,39
	GGP320032E	32 x 1 1/4"	16	10	120		2,39
	GGP320040D	40 x 1"	16		80		4,36
	GGP320040E	40 x 1 1/4"	16		70		4,36
	GGP320040F	40 x 1 1/2"	16		70		4,36
	GGP320050E	50 x 1 1/4"	16		45		5,76
	GGP320050F	50 x 1 1/2"	16		45		5,76
	GGP320050G	50 x 2"	16		45		5,76
	GGP320063F	63 x 1 1/2"	16		25		8,36
	GGP320063G	63 x 2"	16		25		8,36
	GGP320075G	75 x 2"	10		25		27,91
	GGP320075H	75 x 2 1/2"	10		25		27,91
	GGP320075I	75 x 3"	10		25		27,91
	GGP320090G	90 x 2	10		13		33,48
	GGP320090H	90 x 2 1/2"	10		13		33,48
	GGP320090I	90 x 3"	10		13		33,48
	GGP320090L	90 x 4"	10		13		33,48
	GGP320110I	110 x 3"	10		8		63,14
	GGP320110L	110 x 4"	10		8		63,14

Female Adaptor / Raccord Femelle / Anschlußverschraubungen IG / Raccordo Femmina / Accessorio Hembra

	Code / Codice	d x Rp (UNI EN 10226)	PN / PFA	Q.tà min / Min. q.ty	Box	Pack / Imballo	€
330 	GGP330020B	20 x 1/2"	16	20	360		1,83
	GGP330020C	20 x 3/4"	16	20	360		1,83
	GGP330025B	25 x 1/2"	16	10	250		2,11
	GGP330025C	25 x 3/4"	16	10	250		2,11
	GGP330025D	25 x 1"	16	10	250		2,11
	GGP330032B	32 x 1/2"	16	10	120		2,75
	GGP330032C	32 x 3/4"	16	10	120		2,75
	GGP330032D	32 x 1"	16	10	120		2,75
	GGP330040D	40 x 1"	16		80		4,52
	GGP330040E	40 x 1 1/4"	16		70		4,52
	GGP330040F	40 x 1 1/2"	16		70		4,52
	GGP330050E	50 x 1 1/4"	16		45		6,26
	GGP330050F	50 x 1 1/2"	16		45		6,26
	GGP330050G	50 x 2"	16		45		6,33
	GGP330063F	63 x 1 1/2"	16		25		9,66
	GGP330063G	63 x 2"	16		25		9,66
	GGP330075G	75 x 2"	10		25		27,91
	GGP330075H	75 x 2 1/2"	10		25		27,91
	GGP330090I	90 x 3"	10		12		34,71
	GGP330110I	110 x 3"	10		7		79,52
GGP330110L	110 x 4"	10		7		79,52	

Tee 90° / Tè a 90° / T-Stück 90° / Ti a 90° / Te a 90°

	Code / Codice	d	PN / PFA	Q.tà min / Min. q.ty	Box	Pack / Imballo	€
340 	GDP3400200	20 x 20 x 20	16	20	100		3,72
	GDP3400250	25 x 25 x 25	16	10	70		4,89
	GDP3400320	32 x 32 x 32	16	10	40		6,42
	GDP3400400	40 x 40 x 40	16		20		10,42
	GDP3400500	50 x 50 x 50	16		15		14,21
	GDP3400630	63 x 63 x 63	16		8		21,50
	GDP3400750	75 x 75 x 75	10		7		60,36
	GDP3400900	90 x 90 x 90	10		6		81,68
	GDP3401100	110 x 110 x 110	10		8		156,56

Male Tee 90° / Tè a 90° avec deriv. Filettées mâle / T-Stück 90° AG / Ti a 90° con Derivazione Filettata Maschio / Te a 90° Rosca Macho

	Code / Codice	d x R (UNI EN 10226)	PN / PFA	Q.tà min / Min. q.ty	Box	Pack / Imballo	€
341 	GGP341020B	20 x 1/2"	16	20	140		3,21
	GGP341020C	20 x 3/4"	16	20	140		3,21
	GGP341025C	25 x 3/4"	16	10	80		4,10
	GGP341025D	25 x 1"	16	10	80		4,10
	GGP341032D	32 x 1"	16	10	50		5,14
	GGP341032E	32 x 1 1/4"	16	10	40		5,14
	GGP341040E	40 x 1 1/4"	16		30		9,16
	GGP341040F	40 x 1 1/2"	16		30		9,16
	GGP341050F	50 x 1 1/2"	16		20		12,60
	GGP341050G	50 x 2"	16		20		12,60
	GGP341063G	63 x 2"	16		10		24,59
	GGP341075H	75 x 2 1/2"	10		10		51,50
	GGP341075I	75 x 3"	10		10		51,50
	GGP341090I	90 x 3"	10		7		74,88
	GGP341110L	110 x 4"	10		10		121,54

Female Tee 90° / Tè a 90° FIL. F / T-Stück 90° IG / Ti a 90° con Derivazione Filettata Femmina / Te a 90° Rosca Hembra

	Code / Codice	d x Rp (UNI EN 10226)	PN / PFA	Q.tà min / Min. q.ty	Box	Pack / Imballo	€
342 	GGP342020B	20 x 1/2"	16	20	140		3,01
	GGP342020C	20 x 3/4"	16	20	140		3,01
	GGP342025B	25 x 1/2"	16	10	80		4,11
	GGP342025C	25 x 3/4"	16	10	80		4,11
	GGP342025D	25 x 1"	16	10	80		4,11
	GGP342032C	32 x 3/4"	16	10	60		4,81
	GGP342032D	32 x 1"	16	10	50		4,81
	GGP342032E	32 x 1 1/4"	16	10	40		4,81
	GGP342040D	40 x 1"	16		30		9,27
	GGP342040E	40 x 1 1/4"	16		30		9,27
	GGP342040F	40 x 1 1/2"	16		30		9,27
	GGP342050F	50 x 1 1/2"	16		20		13,44
	GGP342050G	50 x 2"	16		20		13,44
	GGP342063G	63 x 2"	16		10		18,47
	GGP342075H	75 x 2 1/2"	10		10		54,28
	GGP342075I	75 x 3"	10		10		54,28
	GGP342090I	90 x 3"	10		7		74,26
	GGP342110L	110 x 4"	10		10		110,93

Male Elbow 90° / Coude 90° Fil. M / Winkel 90° AG / Gomito a 90° Fil M / Codo 90° Rosca Macho

	Code / Codice	d	PN / PFA	Q.tà min / Min. q.ty	Box	Pack / Imballo	€
350 	GDP3500200	20 x 20	16	20	200		2,82
	GDP3500250	25 x 25	16	10	120		3,20
	GDP3500320	32 x 32	16	10	60		4,25
	GDP3500400	40 x 40	16		40		7,50
	GDP3500500	50 x 50	16		25		10,34
	GDP3500630	63 x 63	16		12		15,06
	GDP3500750	75 x 75	10		12		42,44
	GDP3500900	90 x 90	10		8		54,59
	GDP3501100	110 x 110	10		11		105,27

Male Elbow 90° / Coude a 90° avec deriv. Filettées mâle / Winkel 90° AG / Gomito a 90° con derivazione Filettato Maschio / Codo 90° Rosca Macho

	Code / Codice	d x R (UNI EN 10226)	PN / PFA	Q.tà min / Min. q.ty	Box	Pack / Imballo	€
351 	GGP351020B	20 x 1/2"	16	20	240		1,94
	GGP351020C	20 x 3/4"	16	20	240		1,92
	GGP351025C	25 x 3/4"	16	10	180		2,20
	GGP351025D	25 x 1"	16	10	180		2,20
	GGP351032D	32 x 1"	16	10	100		2,98
	GGP351032E	32 x 1 1/4"	16	10	100		2,98
	GGP351040E	40 x 1 1/4"	16		40		4,73
	GGP351040F	40 x 1 1/2"	16		40		4,73
	GGP351050F	50 x 1 1/2"	16		30		6,59
	GGP351050G	50 x 2"	16		30		6,59
	GGP351063G	63 x 2"	16		20		10,09
	GGP351075H	75 x 2 1/2"	10		18		32,86
	GGP351075I	75 x 3"	10		18		32,86
	GGP351090I	90 x 3"	10		12		39,86
	GGP351110L	110 x 4"	10		7		76,22

Female Elbow 90° / Coude 90° Fil. F / Winkel 90° IG / Gomito a 90° con derivazione Filettata Femmina / Codo 90° Rosca Hembra

	Code / Codice	d x Rp (UNI EN 10226)	PN / PFA	Q.tà min / Min. q.ty	Box	Pack / Imballo	€
352 	GGP352020B	20 x 1/2"	16	20	240		2,11
	GGP352020C	20 x 3/4"	16	20	240		2,11
	GGP352025B	25 x 1/2"	16	10	180		2,66
	GGP352025C	25 x 3/4"	16	10	180		2,66
	GGP352025D	25 x 1"	16	10	180		2,66
	GGP352032C	32 x 3/4"	16	10	100		3,14
	GGP352032D	32 x 1"	16	10	100		3,14
	GGP352032E	32 x 1 1/4"	16	10	100		3,14
	GGP352040E	40 x 1 1/4"	16		40		6,18
	GGP352040F	40 x 1 1/2"	16		40		6,18
	GGP352050F	50 x 1 1/2"	16		30		8,23
	GGP352050G	50 x 2"	16		30		8,57
	GGP352063G	63 x 2"	16		20		12,24
	GGP352075H	75 x 2 1/2"	10		20		33,48
	GGP352090I	90 x 3"	10		18		62,42
	GGP352110L	110 x 4"	10		6		102,10

Clamp Saddles / Collier de Prise / Anbohrschellen Prese a Staffa / Collarín de Fijación

Clamp Saddles / Collier de Prise / Anbohrschellen Prese a Staffa / Collarín de Fijación



Code Codice	d	N° Fori bolts	PN / PFA	Box	€	Code / Codice	d	N° Fori / bolts	PN / PFA	Box	€
SEP010020B	20 x 1/2"	2	6	175	1,24	SEP010125H	125 x 2 1/2"	4	6	6	16,32
SEP010025B	25 x 1/2"	2	6	175	1,24	SEP010125I	125 x 3"	4	6	6	16,32
SEP010025C	25 x 3/4"	2	6	175	1,24	SEP010140C	140 x 3/4"	6	6	9	19,83
SEP010032B	32 x 1/2"	2	6	100	1,42	SEP010140D	140 x 1"	6	6	9	19,83
SEP010032C	32 x 3/4"	2	6	100	1,42	SEP010140E	140 x 1 1/4"	6	6	9	19,83
SEP010032D	32 x 1"	2	6	100	1,42	SEP010140F	140 x 1 1/2"	6	6	9	19,83
SEP010040B	40 x 1/2"	2	6	70	1,61	SEP010140G	140 x 2"	6	6	9	19,83
SEP010040C	40 x 3/4"	2	6	70	1,61	SEP010140I	140 x 3"	6	6	9	19,83
SEP010040D	40 x 1"	2	6	70	1,61	SEP010140L	140 x 4"	6	6	9	19,83
SEP010050B	50 x 1/2"	2	6	60	1,76	SEP010160B	160 x 1/2"	6	6	8	19,83
SEP010050C	50 x 3/4"	2	6	60	1,76	SEP010160C	160 x 3/4"	6	6	8	19,83
SEP010050D	50 x 1"	2	6	60	1,76	SEP010160D	160 x 1"	6	6	8	19,83
SEP010063B	63 x 1/2"	4	6	35	3,03	SEP010160E	160 x 1 1/4"	6	6	8	19,83
SEP010063C	63 x 3/4"	4	6	35	3,03	SEP010160F	160 x 1 1/2"	6	6	8	19,83
SEP010063D	63 x 1"	4	6	35	3,03	SEP010160G	160 x 2"	6	6	7	19,83
SEP010063E	63 x 1 1/4"	4	6	35	3,03	SEP010160H	160 x 2 1/2"	6	6	7	19,83
SEP010063F	63 x 1 1/2"	4	6	35	3,03	SEP010160I	160 x 3"	6	6	7	19,83
SEP010075B	75 x 1/2"	4	6	30	4,33	SEP010160L	160 x 4"	6	6	7	20,96
SEP010075C	75 x 3/4"	4	6	30	4,33	SEP010200D	200 x 1"	6	10	8	53,77
SEP010075D	75 x 1"	4	6	30	4,33	SEP010200E	200 x 1 1/4"	6	10	8	53,77
SEP010075E	75 x 1 1/4"	4	6	25	4,33	SEP010200F	200 x 1 1/2"	6	10	8	53,77
SEP010075F	75 x 1 1/2"	4	6	25	4,33	SEP010200G	200 x 2"	6	10	8	57,58
SEP010075G	75 x 2"	4	6	20	4,33	SEP010200I	200 x 3"	6	10	8	57,58
SEP010090B	90 x 1/2"	4	6	20	4,88	SEP010200L	200 x 4"	6	10	8	57,58
SEP010090C	90 x 3/4"	4	6	20	4,88	SEP010225B	225 x 3/4"	6	10	6	61,80
SEP010090D	90 x 1"	4	6	20	4,88	SEP010225D	225 x 1"	6	10	6	61,80
SEP010090E	90 x 1 1/4"	4	6	15	4,88	SEP010225E	225 x 1 1/4"	6	10	6	61,80
SEP010090F	90 x 1 1/2"	4	6	15	5,01	SEP010225F	225 x 1 1/2"	6	10	6	61,80
SEP010090G	90 x 2"	4	6	15	5,01	SEP010225G	225 x 2"	6	10	6	61,80
SEP010110B	110 x 1/2"	4	6	15	6,12	SEP010225I	225 x 3"	6	10	6	67,41
SEP010110C	110 x 3/4"	4	6	15	6,12	SEP010225L	225 x 4"	6	10	6	67,41
SEP010110D	110 x 1"	4	6	15	6,12	SEP010250D	250 x 1"	6	10	4	74,37
SEP010110E	110 x 1 1/4"	4	6	12	6,12	SEP010250E	250 x 1 1/4"	6	10	4	74,37
SEP010110F	110 x 1 1/2"	4	6	12	6,86	SEP010250F	250 x 1 1/2"	6	10	4	74,37
SEP010110G	110 x 2"	4	6	12	6,86	SEP010250G	250 x 2"	6	10	4	74,37
SEP010110H	110 x 2 1/2"	4	6	12	8,93	SEP010250I	250 x 3"	6	10	4	74,37
SEP010110I	110 x 3"	4	6	12	12,15	SEP010250L	250 x 4"	6	10	4	74,37
SEP010125B	125 x 1/2"	4	6	10	15,7	SEP010315D	315 x 1"	6	10	3	93,27
SEP010125C	125 x 3/4"	4	6	10	15,81	SEP010315E	315x1 1/2"	6	10	3	93,27
SEP010125D	125 x 1"	4	6	10	15,81	SEP010315F	315 x 1 1/4"	6	10	3	93,27
SEP010125E	125 x 1 1/4"	4	6	10	15,81	SEP010315G	315 x 2"	6	10	3	102,85
SEP010125F	125 x 1 1/2"	4	6	10	15,81	SEP010315I	315 x 3"	6	10	3	102,85
SEP010125G	125 x 2"	4	6	10	16,32	SEP010315L	315 x 4"	6	10	3	102,85

Clamp Saddles Reinforced / Colliers de Prise avec Anneau de Renforcement / Anbohrschellen mit Verstärkerungsring Prese a Staffa con Anello di Rinforzo / Collarín con Anillo de Refuerzo



Code Codice	d	N° Fori bolts	PN / PFA	Box	€	Code / Codice	d	N° Fori / bolts	PN / PFA	Box	€
SEP011020B	20 x 1/2"	2	10	150	2,06	SEP011125L	125 x 4"	4	10	6	17,46
SEP011025B	25 x 1/2"	2	10	175	2,06	SEP011140C	140 x 3/4"	6	10	9	20,09
SEP011025C	25 x 3/4"	2	10	175	2,06	SEP011140D	140 x 1"	6	10	9	20,09
SEP011032B	32 x 1/2"	2	10	100	2,41	SEP011140E	140 x 1 1/4"	6	10	9	20,09
SEP011032C	32 x 3/4"	2	10	100	2,41	SEP011140F	140 x 1 1/2"	6	10	9	20,09
SEP011032D	32 x 1"	2	10	100	2,41	SEP011140G	140 x 2"	6	10	9	20,09
SEP011040B	40 x 1/2"	2	10	70	2,68	SEP011140I	140 x 3"	6	10	9	20,09
SEP011040C	40 x 3/4"	2	10	70	2,68	SEP011140L	140 x 4"	6	10	9	20,09
SEP011040D	40 x 1"	2	10	70	2,68	SEP011160B	160 x 1/2"	6	10	8	20,09
SEP011050B	50 x 1/2"	2	10	60	2,78	SEP011160C	160 x 3/4"	6	10	8	20,09
SEP011050C	50 x 3/4"	2	10	60	2,78	SEP011160D	160 x 1"	6	10	8	20,09
SEP011050D	50 x 1"	2	10	60	2,78	SEP011160E	160 x 1 1/4"	6	10	8	20,09
SEP011063B	63 x 1/2"	4	10	35	4,22	SEP011160F	160 x 1 1/2"	6	10	8	20,09
SEP011063C	63 x 3/4"	4	10	35	4,22	SEP011160G	160 x 2"	6	10	7	20,09
SEP011063D	63 x 1"	4	10	35	4,22	SEP011160H	160 x 2 1/2"	6	10	7	21,22
SEP011063E	63 x 1 1/4"	4	10	35	4,22	SEP011160I	160 x 3"	6	10	7	21,22
SEP011063F	63 x 1 1/2"	4	10	35	4,22	SEP011160L	160 x 4"	6	10	7	23,38
SEP011075B	75 x 1/2"	4	10	30	5,25	SEP011200C	200 x 3/4"	6	10	8	84,81
SEP011075C	75 x 3/4"	4	10	30	5,25	SEP011200D	200 x 1"	6	10	8	84,81
SEP011075D	75 x 1"	4	10	30	5,25	SEP011200E	200 x 1 1/4"	6	10	8	84,81
SEP011075E	75 x 1 1/4"	4	10	25	5,25	SEP011200F	200 x 1 1/2"	6	10	8	84,81
SEP011075F	75x1 1/2"	4	10	25	5,25	SEP011200G	200 x 2"	6	10	8	84,81
SEP011075G	75 x 2"	4	10	20	5,25	SEP011200I	200 x 3"	6	10	8	90,76
SEP011090B	90 x 1/2"	4	10	20	5,82	SEP011200L	200 x 4"	6	10	8	90,76
SEP011090C	90 x 3/4"	4	10	20	5,82	SEP011225B	225 x 1/2"	6	10	6	101,40
SEP011090D	90 x 1"	4	10	20	5,82	SEP011225C	225 x 3/4"	6	10	6	101,40
SEP011090E	90 x 1 1/4"	4	10	15	5,82	SEP011225D	225 X 1"	6	10	6	101,40
SEP011090F	90 x 1 1/2"	4	10	15	5,82	SEP011225E	225 x 1 1/4"	6	10	6	101,40
SEP011090G	90 x 2"	4	10	15	5,82	SEP011225F	225 x 1 1/2"	6	10	6	101,40
SEP011110B	110 x 1/2"	4	10	15	6,59	SEP011225G	225 x 2"	6	10	6	105,97
SEP011110C	110 x 3/4"	4	10	15	6,59	SEP011225I	225 x 3"	6	10	6	105,97
SEP011110D	110 x 1"	4	10	15	6,59	SEP011225L	225 x 4"	6	10	6	105,97
SEP011110E	110 x 1 1/4"	4	10	12	6,59	SEP011250D	250 x 1"	6	10	4	118,81
SEP011110F	110 x 1 1/2"	4	10	12	7,22	SEP011250E	250 x 1 1/4"	6	10	4	118,81
SEP011110G	110 x 2"	4	10	12	8,14	SEP011250F	250 x 1 1/2"	6	10	4	124,58
SEP011110H	110 x 2 1/2"	4	10	12	10,20	SEP011250G	250 x 2"	6	10	4	124,58
SEP011110I	110 x 3"	4	10	12	12,57	SEP011250I	250 x 3"	6	10	4	126,23
SEP011125B	125 x 1/2"	4	10	10	15,97	SEP011250L	250 x 4"	6	10	4	126,23
SEP011125C	125 x 3/4"	4	10	10	15,97	SEP011315D	315 x 1"	6	10	3	150,02
SEP011125D	125 x 1"	4	10	10	15,97	SEP011315E	315 x 1 1/4"	6	10	3	150,02
SEP011125E	125 x 1 1/4"	4	10	10	15,97	SEP011315F	315 x 1 1/2"	6	10	3	150,02
SEP011125F	125 x 1 1/2"	4	10	10	15,97	SEP011315G	315 x 2"	6	10	3	156,82
SEP011125G	125 x 2"	4	10	10	15,97	SEP011315I	315 x 3"	6	10	3	156,82
SEP011125H	125 x 2 1/2"	4	10	6	17,46	SEP011315L	315 x 4"	6	10	3	156,82
SEP011125I	125 x 3"	4	10	6	17,46						

Spare Parts For Valves and Fittings
Pieces Detachees Pour Vannes et Raccords
Ersatzteile für Kugelhähne und Fittings
Parti di Ricambio Per Valvole e Raccordi
Piezas de Repuesto Para Válvulas y Accesorios



Union end threaded / Pièce folle pour BOE / Einlegteile / Pezzo folle filettato / Pieza terminal roscada para BOE

	Code / Codice	d	PN / PFA	Q.tà min / Min. q.ty	Box	Pack / Imballo	€
BLE 	RERBLE020B	1/2"					1,48
	RERBLE025C	3/4"					1,65
	RERBLE032D	1"					2,24
	RERBLE040E	1 1/4"					2,78
	RERBLE050F	1 1/2"					3,66
	RERBLE063G	2"					5,02
	RERBLE075H	2 1/2"					12,43
	RERBLE090I	3"					13,50
	RERBLE110L	4"					15,82

Union bush threaded / Pièce filéee pour BOE / Einschraubteile für BFE / Pezzo fisso filettato / Pieza fija roscada para BOE

	Code / Codice	d	PN / PFA	Q.tà min / Min. q.ty	Box	Pack / Imballo	€
BFE 	RERBFE020B	1/2"					1,61
	RERBFE025C	3/4"					1,85
	RERBFE032D	1"					2,36
	RERBFE040E	1 1/4"					2,78
	RERBFE050F	1 1/2"					3,89
	RERBFE063G	2"					5,53
	RERBFE075H	2 1/2"					15,82
	RERBFE090I	3"					18,44
	RERBFE110L	4"					20,65

Union seal EPDM / Joint plats pour pièce union / EPDM Dichtung für Verschraubungen / Guarnizione per bocchettone in EPDM / Juntas para uniones

	Code / Codice	d	PN / PFA	Q.tà min / Min. q.ty	Box	Pack / Imballo	€
GBO EPDM 	RGRGB0020P	20					0,47
	RGRGB0025P	25					0,57
	RGRGB0032P	32					0,63
	RGRGB0040P	40					0,73
	RGRGB0050P	50					1,08
	RGRGB0063P	63					1,31
	RGRGB0075P	75					2,20
	RGRGB0090P	90					2,36
	RGRGB0110P	110					4,40

Backnut for Valves / Ecrou pour Vannes / Überwurfmutter für Kugelhähne / Ghiera per valvole / Tuerca para Válvulas

	Code / Codice	mm	PN / PFA	Q.tà min / Min. q.ty	Box	Pack / Imballo	€
GHI 	BDRGHI0200	20					0,55
	BDRGHI0250	25					0,66
	BDRGHI0320	32					0,77
	BDRGHI0400	40					0,99
	BDRGHI0500	50					1,53
	BDRGHI0630	63					2,52
	BDRGHI0900	90					10,82
	BDRGHI1100	110					16,16

Socket for valves / Manchon pour Vannes / Muffe für Kugelhähne / Manicotto per valvole / Manguito para Válvulas

	Code/Codice Threaded/Filettato	d	€	Code/Codice Solvent cement/Incollaggio	d	€
MAN 	BERMAN0160	3/8"	0,87	BDRMAN0160	16	0,44
	BERMAN0200	1/2"	0,87	BDRMAN0200	20	0,44
	BERMAN0250	3/4"	0,99	BDRMAN0250	25	0,55
	BERMAN0320	1"	1,09	BDRMAN0320	32	0,66
	BERMAN0400	1 1/4"	1,31	BDRMAN0400	40	0,77
	BERMAN0500	1 1/2"	1,75	BDRMAN0500	50	0,99
	BERMAN0630	2"	2,18	BDRMAN0630	63	1,64
	BERMAN0750	2 1/2"	6,01	BDRMAN0750	75	4,92
	BERMAN0900	3"	6,45	BDRMAN0900	90	5,14
	BERMAN1100	4"	9,29	BDRMAN1100	110	7,64

Union Bush for BOD / Mamelon pour BOD / Einschraubteile / Pezzo fisso per BOD / Pieza Fija para BOD

	Code / Codice	d	PN / PFA	Q.tà min / Min. q.ty	Box	Pack / Imballo	€
BFD 	RDRBFD0200	20					1,19
	RDRBFD0250	25					1,39
	RDRBFD0320	32					1,86
	RDRBFD0400	40					2,41
	RDRBFD0500	50					3,04
	RDRBFD0630	63					3,95
	RDRBFD0750	75					10,92
	RDRBFD0900	90					11,59
	RDRBFD1100	110					14,36

Union End for BOD-BOG / Embout pour BOD-BOG / Einlegteile für BOD / Pezzo folle per BOD / Pieza terminal para BOD

	Code / Codice	d	PN / PFA	Q.tà min / Min. q.ty	Box	Pack / Imballo	€
BLD 	RDRBLD0200	20					1,04
	RDRBLD0250	25					1,04
	RDRBLD0320	32					1,22
	RDRBLD0400	40					1,54
	RDRBLD0500	50					2,04
	RDRBLD0630	63					3,79
	RDRBLD0750	75					7,52
	RDRBLD0900	90					8,96
	RDRBLD1100	110					10,99

Nut for Union / Ecrou pour embout / Überwurfmutter für BOD / Ghiera per bocchettoni / Tuerca para unión

	Code / Codice	d	PN / PFA	Q.tà min / Min. q.ty	Box	Pack / Imballo	€
BGD 	RDRBGD0200	20					1,18
	RDRBGD0250	25					1,34
	RDRBGD0320	32					1,77
	RDRBGD0400	40					2,33
	RDRBGD0500	50					2,86
	RDRBGD0630	63					4,41
	RDRBGD0750	75					14,26
	RDRBGD0900	90					16,39
	RDRBGD1100	110					20,38

Spring / Réssort / Feder / Molla / Muelle

	Code / Codice	mm-spire	PN / PFA	Q.tà min / Min. q.ty	Box	Pack / Imballo	€
CDR-MOL 	CDRMOL0200	20					2,10
	CDRMOL0250	25					2,17
	CDRMOL0320	32					2,72
	CDRMOL0400	40					3,94
	CDRMOL0500	50					4,36
	CDRMOL0630	63					6,46
	CDRMOL0900	90					12,26
	CDRMOL1100	110					14,06

PTFE Spring / Réssort PTFE / PTFE Feder / Molla PTFE / Muelle recubierto de PTFE

	Code / Codice	mm	PN / PFA	Q.tà min / Min. q.ty	Box	Pack / Imballo	€
CDR-MOX 	CDRMOX0200	20					11,69
	CDRMOX0250	25					12,21
	CDRMOX0320	32					12,73
	CDRMOX0400	40					13,59
	CDRMOX0500	50					13,87
	CDRMOX0630	63					16,67
	CDRMOX0900	90					22,22
	CDRMOX1100	110					24,45

EPDM and PTFE Seal Kit for Industrial Ball Valves / Sièges et joints / Kit für Kugelhähne Industrie EPDM und PTFE
Set Guarnizioni EPDM e PTFE per Valvola Sfera industria / Kit para Válvulas Industria y Bola

	Code / Codice EPDM	€	Code / Codice FKM	€	d	PN / PFA	Q.tà min Min. q.ty	Box	Pack Imballo
	BDRKIT0200	0,90	BDRKIT020V	1,90	20				
	BDRKIT0250	1,10	BDRKIT025V	2,10	25				
	BDRKIT0320	1,50	BDRKIT032V	4,00	32				
	BDRKIT0400	1,80	BDRKIT040V	5,95	40				
	BDRKIT0500	2,10	BDRKIT050V	6,60	50				
	BDRKIT0630	3,60	BDRKIT063V	10,20	63				
	BDRKIT0750	9,15	BDRKIT075V	21,40	75				
	BDRKIT0900	9,15	BDRKIT090V	21,40	90				
	BDRKIT1100	19,50	BDRKIT110V	35,00	110				

Handle for Valve / Poignée pour Vanne / Kugelhähne Handgriff / Maniglia Valvola / Maneta de Válvula

	Code Blue Codice Blu	D Inch.	d	D Inch.	PN / PFA	Q.tà min Min. q.ty	Box	Pack Imballo	€
	BDRHBN0200		20	1/2"					0,87
	BDRHBN0250		25	3/4"					1,04
	BDRHBN0320		32	1"					1,36
	BDRHBN0400		40	1 1/4"					1,53
	BDRHBN0500		50	1 1/2"					1,98
	BDRHBN0630		63	2"					2,37
	BDRHBN0900		75-90	2 1/2" - 3"					5,62
	BDRHBN1100		110	4"					7,49

Handle for Valve / Poignée pour Vanne / Kugelhähne Handgriff / Maniglia Valvola / Maneta de Válvula

	Code Red Codice Rosso	D Inch.	d	D Inch.	PN / PFA	Q.tà min Min. q.ty	Box	Pack Imballo	€
	BDRHAN0200		20	1/2"					0,87
	BDRHAN0250		25	3/4"					1,04
	BDRHAN0320		32	1"					1,36
	BDRHAN0400		40	1 1/4"					1,53
	BDRHAN0500		50	1 1/2"					1,98
	BDRHAN0630		63	2"					2,37
	BDRHAN0900		75-90	2 1/2" - 3"					5,62
	BDRHAN1100		110	4"					7,49

Strainer (HVD - HVE) / Crépine (HVD - HVE) / Saugkorb für HVD-HVE / Succhieruola (HVD - HVE) / Accesorio válvula de pie

	Code / Codice	d	PN / PFA	Q.tà min / Min. q.ty	Box	Pack / Imballo	€
	CDRZVD0200	1/2"			50	S	3,38
	CDRZVD0250	3/4"			50	S	3,89
	CDRZVD0320	1"			50	S	4,69
	CDRZVD0400	1 1/4"			50	S	5,45
	CDRZVD0500	1 1/2"			20	S	8,15
	CDRZVD0630	2"			20	S	9,76
	CDRZVD0750	2 1/2"			10	S	13,66
	CDRZVD0900	3"			10	S	13,83
	CDRZVD1100	4"			10	S	14,81

Thermo Plastic Pressure Pipe Systems

Polypipe Italia

Loc. Pianmercato 5C-5D - 16044 Cicagna (GE) Italy

Tel: +39 0185 92 399 - Fax: +39 0185 92 699

info@polypipeitalia.com - www.polypipeitalia.com